



**SREENIVASA INSTITUTE OF TECHNOLOGY AND  
MANAGEMENT STUDIES**

**CHITTOOR, ANDHRA PRADESH- 517127**

**AN ISO 9001:2015 CERTIFIED INSTITUTION**

**(AUTONOMOUS and ACCREDITED BY NAAC & NBA, PERMANENTLY AFFILIATED TO JNTU ANANTHAPURAMU)**

**DEPARTMENT OF MECHANICAL ENGINEERING**

NOTES FOR

**MANUFACTURING TECHNOLOGY**

**UNIT-I**

**METAL CASTING**

Fundamentals of casting:-

Manufacturing involves turning raw materials to finished products to be used for some purpose.

In fact, manufacturing involves a series of related activities and operations such as:

- ① Product design and development
- ② Material selection
- ③ Process planning
- ④ Inventory control
- ⑤ Quality Assurance
- ⑥ Marketing.

Classification of manufacturing processes:-

- ① Casting:-
  - ① Sand casting
  - ② Shell mould casting
  - ③ Die casting
  - ④ permanent mould casting
  - ⑤ centrifugal casting.

- ② Metal forming processes:-

- ① Rolling
- ② Extrusion
- ③ sheet metal operations
- ④ Wire Drawing
- ⑤ Press forging.

- ③ Fabrication:-
  - ① welding:- Gas welding, Arc welding, Thermit welding, Brazing

- ④ Metal removing processes:-

- ① Machining:-
  - ① Turning
  - ② Drilling
  - ③ Milling
  - ④ Shaping
  - ⑤ Grinding & finishing.

Casting:-

Casting means the pouring of molten metal into a mould, where solidification occurs. After the molten metal solidifies in the mould cavity the product is taken out to get the casting.

Casting is preferred because of the following reasons:-

- ① It is cheap and direct way of producing a shape with desired mechanical properties.
- ② Casting is best suited when different properties are required in different sections of product.
- ③ Cost associated in giving details in casting process is minimum when compared to mechanical working.

4. It is possible to cast practically any material, be it ferrous or non-ferrous.
5. It is possible in the casting process to place the amount of material where it is exactly required.
6. As a result, weight reduction in design can be achieved. The dimensional accuracy and surface finish achieved by normal sand casting process would not be adequate for final application in many cases.

### Casting Terms:-

7. Objects of large size can be produced easily.
8. The objects having complex and complicated shapes which cannot be produced by any other method of production, can usually be cast.

### Disadvantages:-

- ① The time required for the process of making casting is quite long.
- ② Metal casting involves melting of metal which is a highly energy consuming process.
- ③ The working conditions in foundries are quite bad due to heat, dust, fumes, slag etc. Compare to other process.
- ④ Metal casting is still highly labour-intensive. Compared to other processes.
- ⑤ The productivity is less than other automatic processes.

### Casting Terms:-

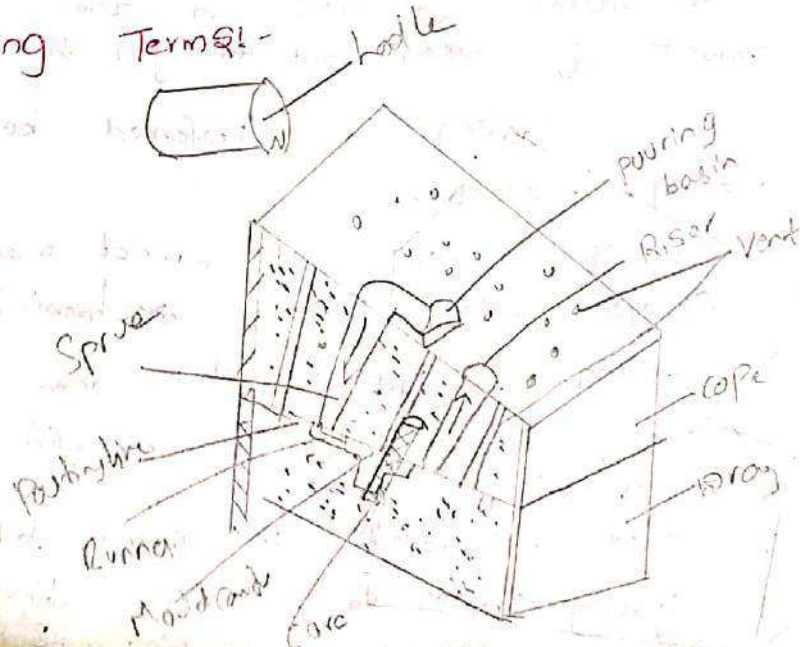

- ① Flask:- A moulding flask is one which holds the sand mould intact. Depending upon the position of the flask in the mould structure, it is referred to various names such as drag, cope and check. It is made of wood for temporary applications or more generally of metal for long-term use.
- ② Drag:- lower - moulding flask
- ③ Cope:- upper - moulding flask
- ④ check:- Intermediate moulding flask used in 3 piece moulding.
- ⑤ pattern:- Pattern is a replica of an object to be made by casting
- ⑥ parting line:- This is the dividing line between the two moulding flasks that makes up the sand mould. In split pattern, it is also the dividing line b/w two halves of pattern.
- ⑦ Bottom Board:- This is a board normally made of wood which is used at the start of the mould making. The pattern is first kept on the bottom board sand is sprinkled on it, and then the ramming is done on the drag.
- ⑧ Core:- It is used for making hollow cavities in castings.
- ⑨ Pouring Basin:- A small funnel-shaped cavity at the top of the mould into which the molten metal is poured.
- ⑩ Sprue:- The passage through which the molten metal from the pouring basin reaches the mould cavity. In many cases, it controls the flow of metal into the mould.
- ⑪ Runner:- The passage way in the parting plane through which molten metal flow is regulated before they reach the mould cavity.
- ⑫ Gate:- The actual entry point through which molten metal enters the mould cavity.
- ⑬ Chaplet:- Chaplets are used to support cores inside the mould cavity to take care of its own weight.
- ⑭ Chill:- Chills are metallic objects, which are placed in the mould to increase the cooling rate of castings to provide uniform or desired cooling rate.

(15)

It is a reservoir of molten metal provided in the casting so that hot metal can flow back into the mould cavity when there is a reduction in volume of metal due to solidification.

Steps involved in Casting process:-

- ① Preparation of a pattern
- ② Preparation of Moulding sand
- ③ Preparation of mould and core
- ④ Melting the metal
- ⑤ pouring of metal into the mould
- ⑥ Cooling and solidification
- ⑦ Removing the casting from the mould
- ⑧ fettling. (i.e., cutting off the unwanted projection in the form of gates, risers, etc.)
- ⑨ Heat Treatment
- ⑩ Testing and inspection.

foundry:- foundry is a plant where the castings are made.

All the foundries are basically two types.

① Jobbing foundries:-

(1) These foundries are most independently owned.

(2) They produce castings on contract, with in their capacity.

② Captive foundries:-

These foundries are usually a department of a big manufacturing company.

## Pattern:-

Object to be made by casting process with some modifications. The main modifications are

- (a) the addition of pattern allowances
- (b) the provision of core prints.

### Requirements of a good pattern:-

- (1) Light in weight
- (2) convenient to handle
- (3) simple in design and ease of manufacture.
- (4) Smooth and wear resistant surface
- (5) Retain its dimension and rigidity during the definite service life.
- (6) High strength and long life.
- (7) Secure the desired shape and size of the casting
- (8) cheap and readily repairable.

### Pattern Materials:-

- (1) Wood
- (2) Metal
- (3) plastic
- (4) Quick setting Compounds.

- (1) Wood:-
1. The wood used for pattern making should be properly dried and seasoned
  2. It should be straight grained
  3. It should be free from insects and excessive sap wood.

- Adv:-
- (1) cheapness
  - (2) ease of availability
  - (3) lightness.
  - (4) ease of joining.

### Limitations:-

- (1) Easily affected by moisture, its shape changes by change in moisture content.
- (2) It wears out quickly by sand abrasion.
- (3) It cannot stand rough usage.

The following types of wood are:-

#### (1) White pine:-

- (a) It is most widely used wood.
- (b) It is soft and easy to work.

#### (2) Mahogany:-

When straight grained, it be worked easily.

- (2) It is harder and more durable.

③ Maple, Kirch and cherry:-

① These woods tend to warp in large sections, as such these should be used for small patterns only.

② They are heavier and harder than white pine.

② Metal:- Where durability and strength are required, patterns are made from metals.

② Metal pattern can be either cast from master wooden pattern or may be machined by the usual methods of machining.

Adv:-

- ① Resistant to wear, abrasion corrosion
- ② possesses a smooth surface.
- ③ Do not undergo deformation in storage
- ④ More durable and accurate in size than wooden patterns.

Limitations:-

- ① Cannot be repaired easily.
- ② More expensive than wooden patterns.
- ③ Heavier than wooden patterns.

The following metals are commonly used for

Pattern making:-

① Aluminium:-

- ② It is light in weight
- ③ It is corrosion resistant

② Brass:-

- ① It has a smooth, closed pore structure.

③ Cast iron:-

- ① Cast iron with fine grain can be used as a pattern material.

- ② It is cheaper and more durable than other metals.

③ Plastic:-

- ① Highly resistant to corrosion and stronger than wood
- ② Lighter pattern.

- ③ The production process is facilitated

- ④ No moisture absorption.

## ④ Quick setting Compounds:-

- ① Gypsum patterns are capable of producing castings with intricate details and to very close tolerances.
- ② Gypsum can be easily formed, has plasticity and can be easily repaired.

## Types of patterns:-

### ① Single - piece pattern:-

1. It is simplest of all the patterns and the cheapest.
2. As the name indicates, they are made of a single piece as shown in figure.
3. This type of pattern is used only in cases where the job is very simple and doesnot create any withdrawal problems.
4. This pattern is expected to be entirely in the drag.
5. Its use can be made to a limited extent of production only since its moulding involves a large number of manual operations like gate cutting, providing runners and risers and the like.

### Application:-

- ① stuffing box
- ② gland of steam engine

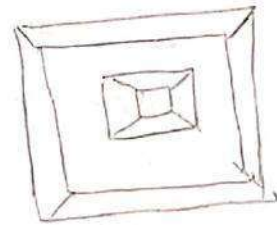
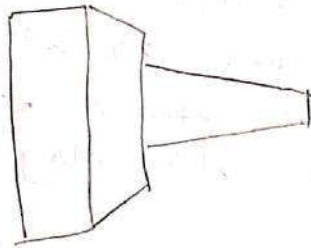

Solid pattern

### ② split pattern (a)

Most of the patterns are not made in a single piece because of the difficulties encountered in moulding them. In order to eliminate this difficulty, some patterns are made in two or more pieces.

A pattern consisting of two pieces is called a two piece split pattern. one-half of the pattern rests in the lower part of the moulding box known as drag and the



Other half is the upper part of the moulding box known as cope. The line of separation of the parts is called parting line.

Applications

- ① Lap joint
- ② Dowel joint

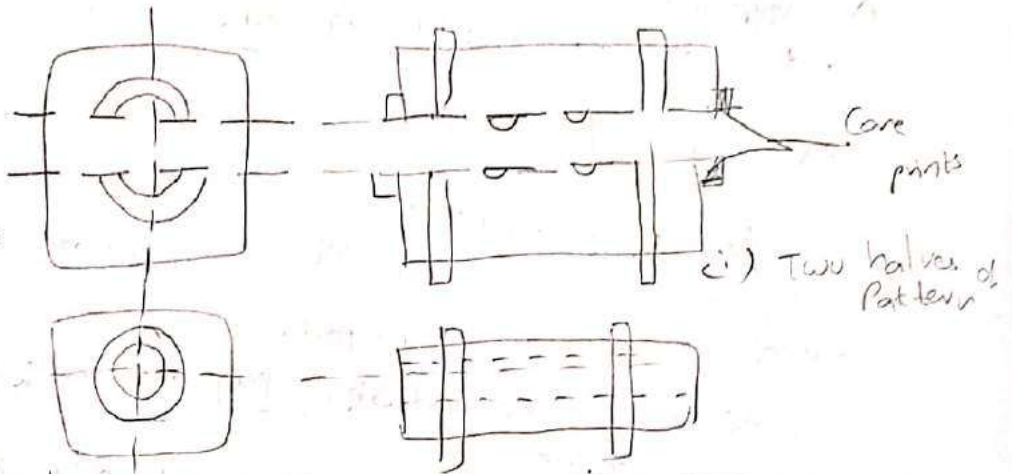

③ Cope and drag patterns:-

(i) Prepared Casting

When very large castings are to be made, the complete pattern becomes too heavy to be handled by a single operator. Such a pattern is made in two parts which are separately moulded in different moulding boxes. After completion of the moulds, two boxes are assembled to form the complete cavity, of which one part is contained by the drag and the other in cope. Here the cope and drag halves of the pattern along with the gating and riser systems are attached separately to the metal or wooden plates along with the alignment pins.

APP:-

- ① Flange pipe
- ② Water jacket of ICES

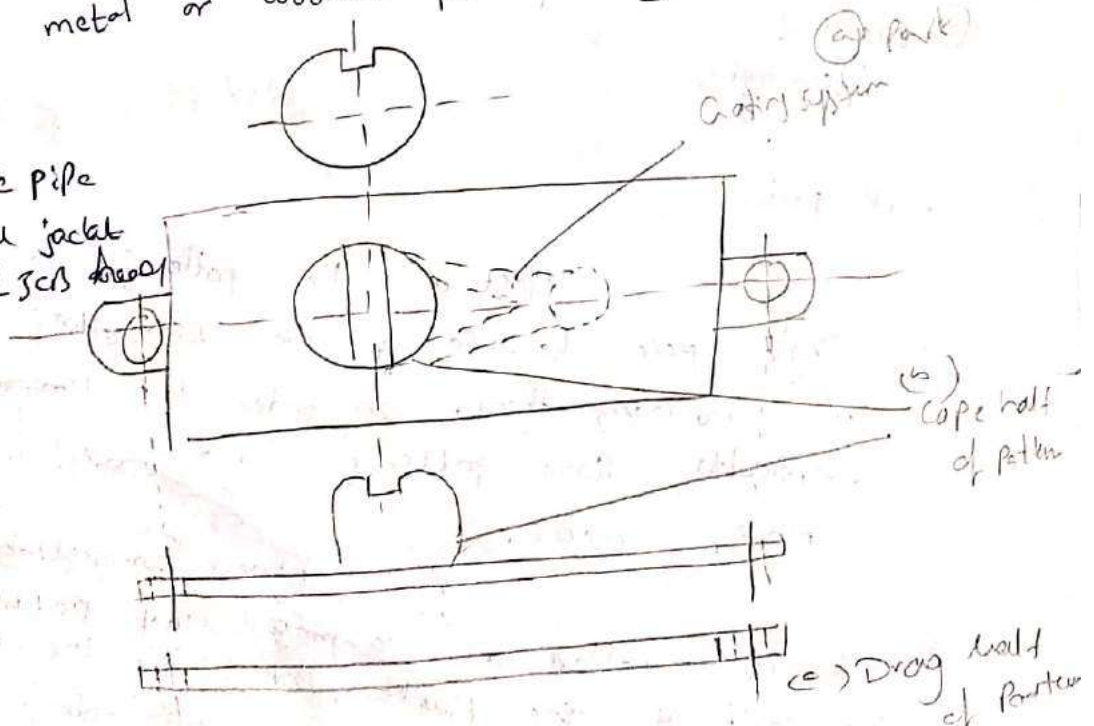

### (H) Loose piece pattern:-

In some cases, a pattern has to be made with projections or overhanging parts. These projections make the removal of the pattern difficult. Therefore such projections are made in loose pieces, and are fastened loosely to the main pattern by means of wooden or wire dowel pins. These pins are taken out during moulding operation. After moulding the main pattern is withdrawn first and then the loose piece is removed by using a lifter.

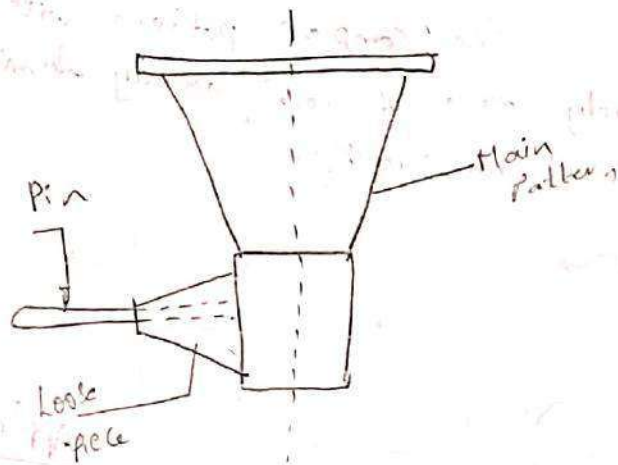

Applica  
 (1) Rotor hub  
 (2) Axial pin

### (E) Gated patterns:-

In production, where several small castings are required, gated patterns are used. This is an improvement over the simple pattern where the gating and runner system are integral with the pattern. This would eliminate hand cutting of the runners and gates and help in improving the productivity of a moulder.

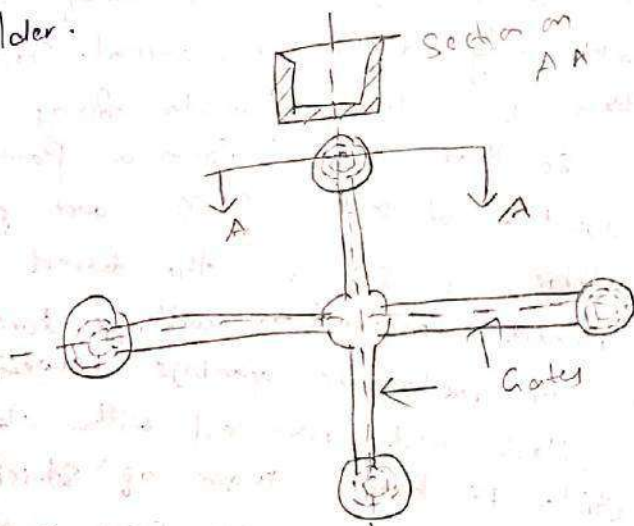

Appli: -  
 Corner bracket

## ⑥ Match plate patterns:-

Here, the cope and drag patterns, along with the gating and the risering are mounted on a single matching metal or wooden plate on either side as shown in fig. on one side of the match plate, the cope flask is prepared and on the other, the drag flask is prepared. After moulding when the match plate is removed, a complete mould with gating is obtained by joining the cope and the drag together.

The complete pattern with match plate is entirely made of metal, usually aluminium, for its light weight and malleability.

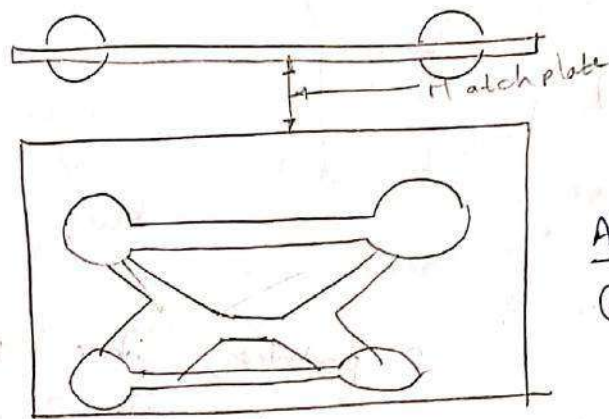

Appl:-

- ① Piston rings of a 3-c engine

## ⑦ Skeleton Pattern:-

When a few large castings are required, it would require a tremendous amount of timber, which may not be economical. In such cases, the pattern is made of wooden frame and rib construction so that it will form a partially or interior outline of the casting and provide the general colour & size of the desired casting. The ribbed construction with a large number of square or rectangular openings between the ribs is filled and rammed with clay sand. A strike off board known as a strickle board is used to scrape the excess sand out of the

spaces between the ribs so as to make the exterior surface even with the outside of the skeleton.



Applications:

Turbine  
Water pipes  
L bends etc.

⑧ Sweep pattern:-

A Sweep is a template of wood or other material which has contour corresponding to the shape and size of casting.

It is used to sweep the complete casting by means of a plane sweep. These are used for generating large shapes, which are air-symmetrical or prismatic in nature such as bell shaped or cylindrical. This greatly reduces the cost of a 3-dimensional pattern.

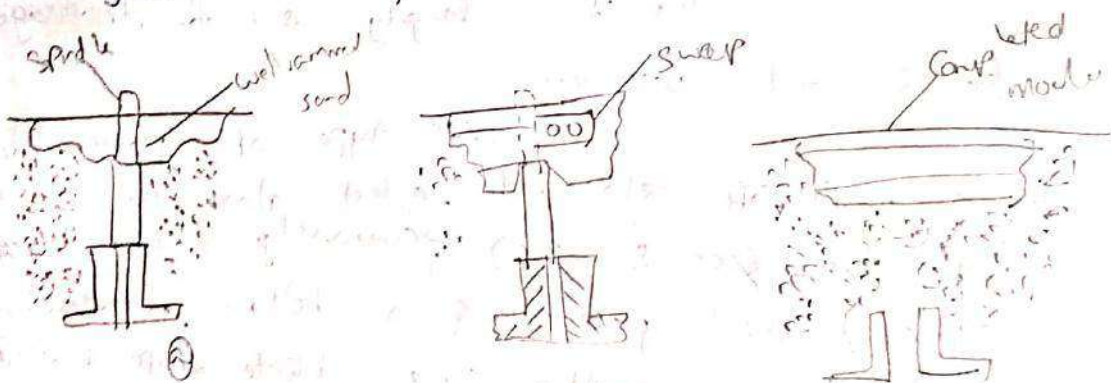

APP:- wheels, rims, large bottles & Castings

⑨ follow-board pattern:-

This type of pattern is adopted for those castings where there are some portions which are structurally weak and if not supported properly are likely to break under the force of ramming. Hence, the bottom board is modified as a follow board to closely fit the contour of the weak pattern and thus support it during the ramming of the drag. During the preparation of the cope, no follow board is necessary because the sand that is already compacted in the drag will support the fragile pattern.

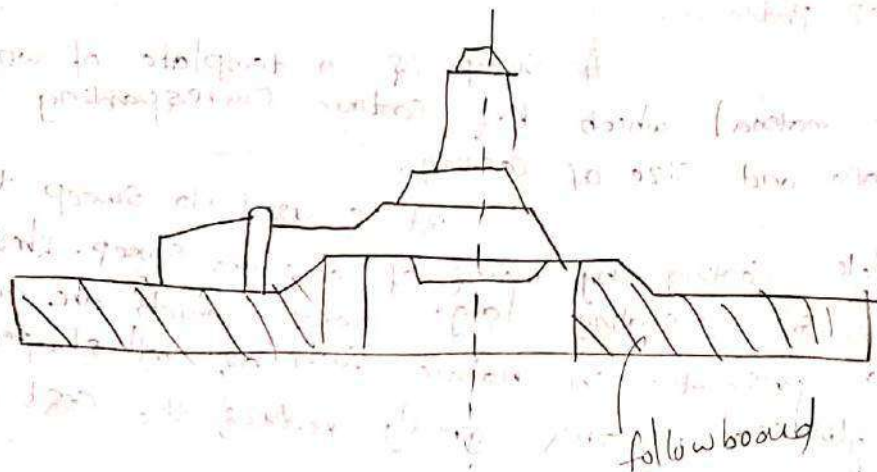

⑩ Shell patterns:-

It is largely used for drainage fittings and pipe work.

This type of pattern is usually made of metal and parted along the centre line, the two sections being accurately doweled together. The shell pattern is a hollow construction like a shell. The outside shape is used as a pattern to make the moulds, while the inside is used as a core box for making cores.

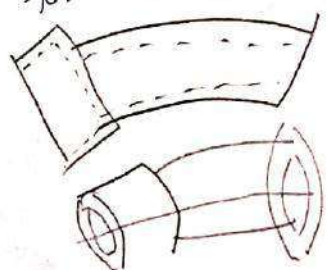

## Moulding Sand types:-

① According to their clay bonding material:

① Natural Sand:

It contains sufficient amount of binding clay and therefore, no more binder is required to be added.

② Synthetic Sand:-

It is one which is artificially compounded by mixing sand and selected type of clay binders etc. These sands have the following advantages:-

① lower cost in large volume    ② widespread availability.

② According to their use:-

① Green Sand:

1. The sand in its natural or moist state is called green sand.

2. It is a mixture of silica sand with 20 to 30% clay, having total amount of water from 6 to 10%.

3. The green sand moulds are used for small size castings of ferrous & non ferrous metals.

② Dry Sand:-

When the moisture from the green sand is evaporated by drying or baking after the mould is made is called dry sand mould.

The dry sand moulds have greater strength, rigidity and thermal stability. The dry sand moulds are used for large and heavy castings.

③ Loam Sand:-

1. The loam sand consists of as high as 50% of clay contents.

2. It is used for loam moulding of large grey-iron castings.

#### 4. facing sand:-

This sand is used next to the pattern to obtain clearer and smoother casting surfaces. Generally sea coal (or) coal dust (finely divided bituminous coal of 2 to 8%) is mixed with the system sand to improve the mouldability and surface finish.

#### ⑤ Parting sand:-

Parting sand is purely clay-free silica sand which is sprinkled on the pattern and the parting surfaces of the mould so that the sand mass of cope and separate without clinging and do not stick to the pattern.

#### ⑥ Backing sand (or) floor sand:-

This is normally the reconditioned foundry sand and is used for ramming the bulk of the moulding flask.

The moulding flask is completely filled with backing sand after the pattern is covered with a thin layer of facing sand.

#### ⑦ Core sand:-

A sand used for the preparation of the core is called <sup>core</sup> sand.

#### Composition of green sand:-

① Silica - up to 75%.

② clay - 8-15%.

③ Bentonite - 2-5%.

④ Coal dust - 5-10%.

⑤ Water - 7-8%.

# Properties of Moulding Sand:-

## ① Moulding Sand properties:-

① Permeability:-  
escape easily

It is the property to allow gases to escape easily from the mould.

Higher the silt content of sand, the lower is gas permeability. If the mould is rammed too hard, its permeability will decrease and vice-versa.

It is measured in number such as 60, 80, 100, 120 etc.

② strength (or) Cohesiveness:-

It is defined as the property

of holding together of sand grains.

A moulding sand should have ample strength so that the mould does not collapse.

The strength of the moulding sand grows with density, clay content of the mix and decreased size of sand grains. Thus as the strength of the moulding sand increases, its porosity decreases.

③ Refractoriness:-

It is the ability of the moulding sand mixture to withstand the heat of melt without showing any sign of softening or fusion.

It increases with the grain size of sand and its content of sand with the diminished amount of impurities.

④ Plasticity or flowability:-

It should be of plastic nature so that it can easily take any

desired shape.

⑤ collapsibility:-

This is the ability of the moulding sand mixture to decrease in volume to some extent

under the compressive forces developed by the shrinkage of metal during freezing and subsequent cooling.



This property permits the moulding sand to collapse easily during shake out and permits the ~~core~~ <sup>core</sup> to collapse easily during its knock out from the cooled casting. Lack of collapsibility in the moulding sand and core may result in the formation of cracks in the casting.

⑥ Adhesiveness:- This is the property of sand mixture to adhere to another body.

The moulding sand should cling to the sides of the moulding boxes so that it does not fall out when the flasks are lifted and turned over. This property depends on the type and amount of binder used in sand mix.

⑦ Coefficient of Expansion:-

The sand should have low coeff of expansion.

⑧ Chemical resistivity

The sand should not chemically react or combine with molten metal.

### Sand Testing:-

In order to meet the required level of accuracy and surface finish of castings the mouldings should be of proper quality. Proper quality of the moulding sand results in sound castings that will decrease the cost per unit and increase the production.

Periodic tests are necessary to determine the essential qualities of foundry sand.

The properties of the moulding sand depend upon shape size, composition and distribution of sand grain. These are standard tests to be used which are given in relevant Indian standards.

Tests are conducted on a sample of standard sand. The moulding sand should be prepared exactly as is done in the workshop on the standard equipment and then carefully enclosed in a closed container to safeguard its moisture content.

B.I.S. has recommended the following tests.

- ① Permeability test
- ② Fineness test (or) Sand grain size test
- ③ Strength test
- ④ Moisture content test
- ⑤ Clay content test
- ⑥ Mohr hardness test

**① Permeability test:** Permeability is the measure of its ability to permit air to flow through it. It is measured in terms of "permeability number".

**Procedure:** To carry out this test, a test specimen of moulding sand (50.8 mm dia & 50.8 mm long) is placed in a specimen tube. Time taken for 2000 cm<sup>3</sup> of air at a pressure of 980 Pa (10 g/cm<sup>2</sup>) to pass through the specimen is noted. Then, the permeability number, P is given as:

$$P = \frac{V \times H}{P \times A \times t}$$

where V = volume of air = 2000 cm<sup>3</sup>  
 H = Height of sand specimen = 50.8 mm = 5.08 cm  
 P = Air pressure = 10 g/cm<sup>2</sup>  
 A = Cross sectional area of sand specimen  
 $= \frac{\pi}{4} \times (5.08)^2 = 20.268 \text{ cm}^2$   
 t = Time in minutes for complete air to pass through.

Substituting the above values

$$P = \frac{2000 \times 5.08}{10 \times 20.268 \times t} = \frac{50.24}{P \cdot t}$$

This permeability number is a relative number. It does not necessarily tell the permeability of a mould made with the same sand which depends on the compactness of the sand.

**Strength Test:-** The strength of the moulding sands can be carried out on the universal sand strength testing machine. The strength can be measured in compression, shear and tension.

The sands that could be tested are green sand, dry sand or core sand.

(1) Green Compressive strength: It refers to the stress required to fracture the sand specimen under compressive loading. The sand specimen is taken out of the specimen tube and is immediately put in the strength testing machine and forces required to cause the compressor failure is determined.

The green strength of sands is generally on the range of 30 to 160 kPa.

**3. Moisture content test:-** Moisture content may be determined by loss of weight after evaporation.

procedure:-

To test the moisture of a moulding sand a carefully weighted sample of 50g is dried at a temp of 105°C to 110°C for 2 hours by which time all the moisture in the sand would have been evaporated.

The sample is then weighted. The weight difference in grams divided by the weight of sample (50g) and multiplied by 100 gives the percentage of moisture contained in the moulding sand.

- 4. **Clay Content test**:- The clay content of moulding sand is determined by dissolving or washing it off the sand.

**Procedure**:-

① A 50g sample of moulding sand is dried at 105 to 110°C. This dried sample is taken in a one litre glass flask and added with 475 ml of distilled water and 25 ml of a 1% NaOH solution (NaOH 25g per litre). This sample is thoroughly stirred.

② After the stirring for a period of 5 minutes, the sample is diluted with fresh water up to a 150mm graduation mark and sample is left undisturbed for 10 minutes to settle. The sand settles at the bottom and the clay particles washed from the sand would be floating in water.

③ **Mould hardness test**:- The mould hardness is measured by a method similar to the Brinell hardness test.

**Procedure**:- A spring loaded steel ball with a mass of 0.9 kg is indented into the standard sand specimen prepared. The depth of indentation can be directly measured on the scale which shows units 0 to 100. When no penetration occurs, then it is a mould hardness of 100 and when it sinks completely the reading is zero indicating a very soft mould.



Defects in casting:

- ① Blowholes
- ② Misrun
- ③ Cold shut
- ④ Misgatch
- ⑤ Drop
- ⑥ fins (or) flashes
- ⑦ Fusion
- ⑧ Metal penetration
- ⑨ air (or) loosh
- ⑩ Scars and blisters
- ⑪ Hot tears
- ⑫ Swell
- ⑬ slag inclusion
- ⑭ Spinginess
- ⑮ slag holes

① Misgatch: - The defect caused due to misalignment of upper and lower part of the casting and misplacement of the core at the parting line.

Cause: -

- ① Improper alignment of upper and lower part, during mold preparation.
- ② Misalignment of flask.

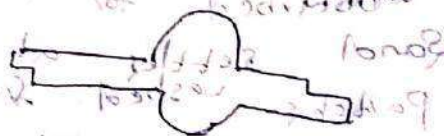

Remedies: -

- ① check the alignment of flask.
- ② correct mountings of pattern.
- ③ proper alignment of the pattern or core part.

② Swell: - It is the enlargement of the mold cavity, because of the molten metal pressure, which results in overall enlargement of casting.

Cause: -

- ① Improper ramming of the mold.

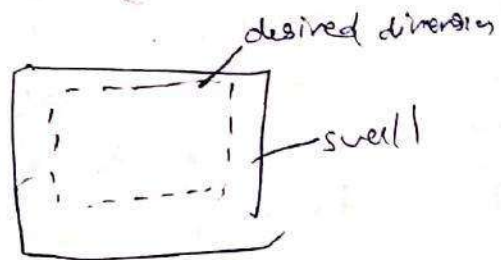

Remedies: -

- ① The sand should be rammed properly evenly.

③ Blow holes:- When gases entrapped on the surface of the casting due to solidifying metal, a rounded or oval cavity is formed called as blowholes. These defects are always present in the cope part of the mould.

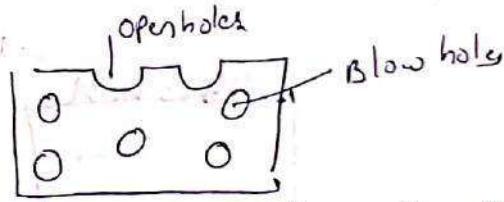

Causes:-

- ① Excessive moisture in the sand
- ② Less permeability of the sand
- ③ Sand grains are too fine
- ④ Too hard rammed sand

Remedies:-

- ① The moisture content in the sand must be controlled and kept at desired level.
- ② High permeability sand should be used.
- ③ Sand of appropriate grain size should be used.
- ④ Sufficient ramming should be done.

④ Drop:- Drop defect occurs when there is cracking on the upper surface of sand and sand pieces fall into the molten metal.

Causes:-

- ① Insufficient fluming
- ② Low strength of sand

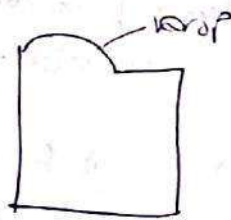

Remedies:-

- ① High strength sand should be used.
- ② There should be proper fluming of molten metal.

### ⑤ Metal Penetration:-

These casting defects appear as an uneven and rough surface of the casting. When the size of sand grains is larger, the molten metal flows into the sand and solidifies, giving up metal penetration defect.

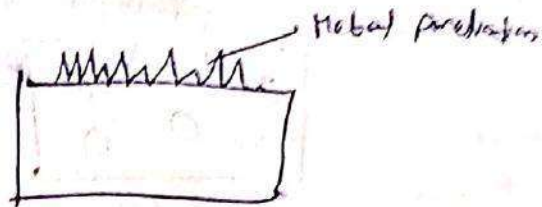

#### Causes:-

It is caused due to low strength, large permeability & soft ramming of sand.

#### Remedies:-

It can be eliminated by using high strength, low permeability.

### ⑥ Misrun:-

When the molten metal solidifies before completely filling the mold cavity and leaves a space in the mold called as misrun.

#### Causes:-

① Low fluidity of the molten metal

② Low temp of molten metal

③ Too thin section

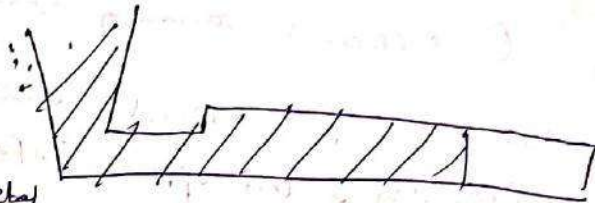

Remedies:- ① Increasing the pouring temp of molten metal

② Too thin section is avoided

### ⑦

#### slag Inclusion:-

This defect is caused when the molten metal containing slag particles is poured in the mold cavity and it gets solidified.

### Causes:-

① The presence of slag in the molten metal

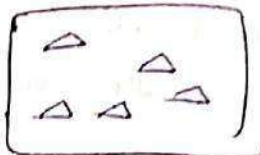

### Remedies:-

Remove slag particles from the molten metal before pouring into mold cavity

② Cold shut:- It is a type of surface defect and a line on the surface can be seen. When the molten metal enters into the mold from two gates and when these two streams of molten metal meet at a junction with low temp than they do not fuse with each other & solidify. Create a cold shut.

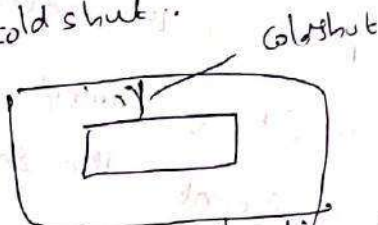

### Causes:-

- ① Lack of fluidity
- ② Poor gating system

### Remedies:-

- ① Improved gating systems
- ② Proper pouring temp

③ Hot cracks:-

When the metal is hot it is weak and the residual stress in the material cause the casting fails as the molten metal cools down. The failure of casting in this case is, looks like cracks and called as hot cracks.

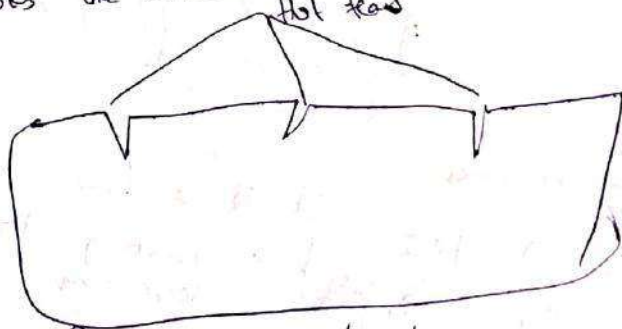

### Causes:-

- ① Improper mold design

### Remedies:-

- ① proper mold design
- ② elimination of residual stress



(10) **Fingering**:- A thin projection of metal, not considered as a part of casting is called as fingering. It usually occurs at the parting of the mold or core section.

**Causes**:-

- ① Incorrect assembly of mold and cores
- ② Improper clamping of plates may produce this

**Remedies**:-

- ① Correct assembly of mold and cores

(11) **Sponginess**:- It is an internal defect in which there is a number of small cavities in close proximity present in the metal casting.

**Causes**:- ① It is caused due to dirt the entry of dirt

**Remedies**:-

- ① Prevent
- ② prevent sand wash

(12)

**Scar and blisters**:-

A scar is a shallow blow. It generally occurs on a flat surface, whereas a blow occurs on a convex casting surface.

A blister is a shallow blow like a scar with a thin layer of metal covering it.

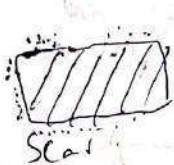

Scar

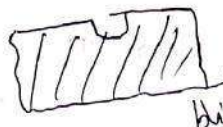

blister

(13)

**Chill or wash**:-

It is a low projection on the drag face of a casting that extends along the surface, decreasing in height as it extends from one side of the casting to the other end.

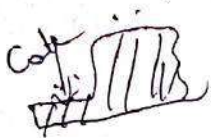

It usually occurs in bottom

pouring castings in which the molding sand has insufficient strength.

(14) Buckles:- A buckle is a long, fairly shallow, broad, Vee depression that occurs in the surface of flat casting. It occurs due to sand expansion caused by the heat of metal, when the sand has insufficient hot deformation. It is also caused due to poor casting design.



(15) Rat tail:- A Rat tail is a shallow, angular depression in the surface of a flat casting and resembles a buckle except that it is not shaped like broad vee.

(16) Pour shot:- It occurs when the mould cavity is incompletely filled because of insufficient metal. This defect occurs due to interruptions during pouring operation, and in sufficient metal in the ladles being used to pour the metal.

Pattern Allowances:-

Certain dimensional allowances must be given in the pattern so that the casting obtained is of the required specifications. While making patterns

- ① Shrinkage allowance
- ② Draft (or) taper allowance.
- ③ Machining Allowance
- ④ Rapping (or) shaking allowance
- ⑤ Distortion allowance.

## ① Shrinkage Allowance:-

① All metals shrink when cooling except Bismuth. This is because of the inter-atomic vibrations which are amplified by an increase in temperature.

Liquid shrinkage refers to the reduction in volume when the metal changes from liquid to solid state at the solidus temperature. To account for this visors are provided in the moulds.

Solid shrinkage of the metal loses temp in solid stage. The actual value of shrinkage depends on various factors specific to a particular casting namely the actual composition of the alloy cast, mould materials used, mould design, complexity of the pattern & component size.

② For example steel contracts to a higher degree compared to aluminium. The shrinkage also depends upon the metallurgical transformation taking place during the solidification.

③ For example white cast iron shrinks by about 21.0 mm/m during casting. However when annealed it grows by about 10.5 mm/m, resulting in a net shrinkage of 10.5 mm/m.

## ② Draft (or) Taper Allowance:-

It is given to all surfaces perpendicular to parting line.

Draft Allowance is given so that the pattern can be easily removed from the moulding material tightly packed around it without damaging the mould cavity.

To reduce the chances of this happening, the vertical faces of the pattern are always tapered from the parting line. This provision is called draft allowance.

The amount of taper depends upon:-

- (1) shape and size of pattern in the depth direction in contact with the mould cavity.
- (2) Moulding methods
- (3) Mould cavity
- (3) Mould material.

Draft allowance varies with the complexity of the job. But in general, inner details of the pattern require higher draft than outer surfaces. The draft allowance given varies for hand moulding and machine moulding. More draft needed to be provided for hand moulding compared to machine moulding.

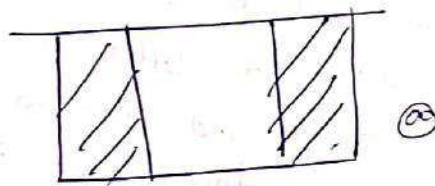

Vertical faces are in contact with sand  
damage

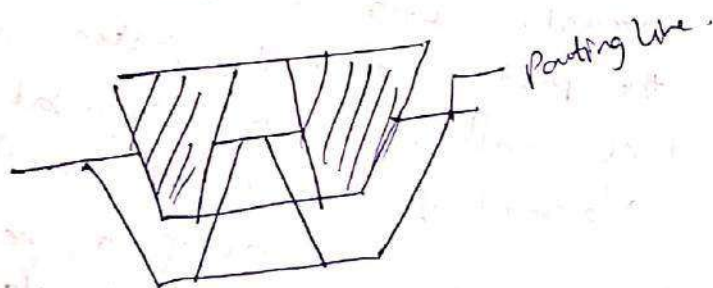

Parting line.

### (3) Machining Allowance

The finish and accuracy achieved in sandcasting are generally poor and therefore, when the casting is functionally required to be of good surface finish or dimensionally accurate, it is generally achieved by subsequent machining. Also ferrous materials would have scale on the skin, which are to be removed by cleaning. Hence, extra material is to be provided which is to be subsequently removed by machining or cleaning process. This depends on

dimensions, the type of casting material and the finish required. This may range from 2 to 20 mm. The machining allowance provided would ultimately have to be removed by machining. Hence cost of providing additional machining allowance should be carefully examined.

The type of machining allowance depends on metal cast, type of mold used, the class of accuracy required on the surface and complexity of surface details.

#### (4) Shaking Allowance:-

Before with draw) from the sand mould, the pattern is rapped (or) shaken all around the vertical faces to enlarge the mould cavity slightly with a wooden piece from side to side. This is done so that the pattern a little or loosened in the mold cavity and can be easily removed. Hence a allowance is provided on the pattern i.e; the pattern dimensions are kept small in order to compensate the enlargement of mould cavity due to rapping.

It is a negative allowance and is to be applied only to those dimensions which are parallel to the parting line. One way of reducing this allowance is to increase the draft, which can be removed during the subsequent machining.

## (5) Distortion Allowance:-

A metal when it has just solidified is very weak and therefore, is likely to be distortion prone. This is particularly so for weak sections such as long flat portions, V, U section or in a complicated casting. The foundry practice should be to make extra material provision for reducing the distortion.

- A casting will distort or warp if
- ① It is of irregular shape
  - ② All its parts do not shrink uniformly i.e.; some parts shrink while others are restricted from doing so, it is U or V shape.

When large number of castings is to be produced, hand moulding consumes more time, labour and also accuracy and uniformity in moulding varies.

Based on the methods of ramming moulding machines are classified as follows.

- ① Jolt machine
- ② Squeeze machine.
- ③ Sand slinger

① Jolt machine - It consists of a flat table mounted on a piston-cylinder arrangement and can be raised or lowered by means of compressed air.

In operation, the mould box with the pattern and sand is placed on the table. The table is raised to a short distance and then dropped down under the

influence of gravity against a solid bed plate.  
 The action of raising and lowering is called jolting.  
 Jolting causes the sand particles to get packed tightly above and around the pattern. The number of "jolts" may vary depending on the size and hardness of the mould required, usually 20 jolts are sufficient for a good moulding.

The disadvantage of this type is that, the density and hardness of the rammed sand at the top of the mould box is less when compared to its bottom portion.

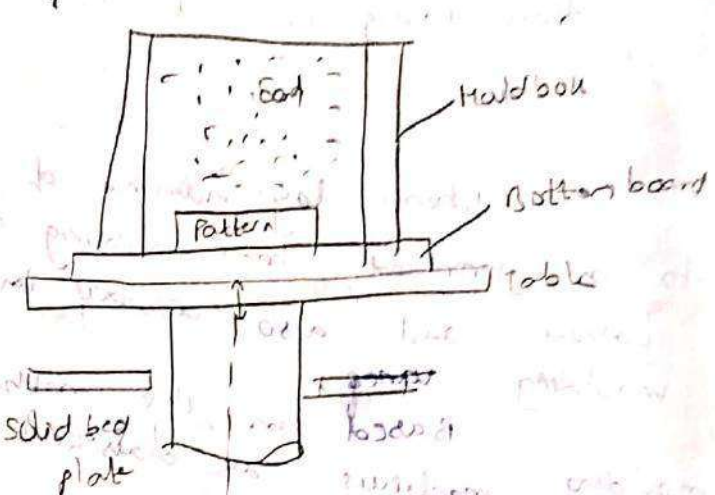

(2)

In a squeeze machine the mould box with pattern and sand in it is placed on a fixed table as shown in figure. A flat plate is brought in contact with the upper surface of the loose sand and pressure is applied by a pneumatically operated piston. The squeezing action of the plate causes the sand particles to get packed tightly above and around the pattern.

Squeezing is continued until the mould attains the desired density.

The disadvantage of squeezer machine is that, the density and hardness of the rammed sand at the bottom of the mould box is less when compared to its top portions.

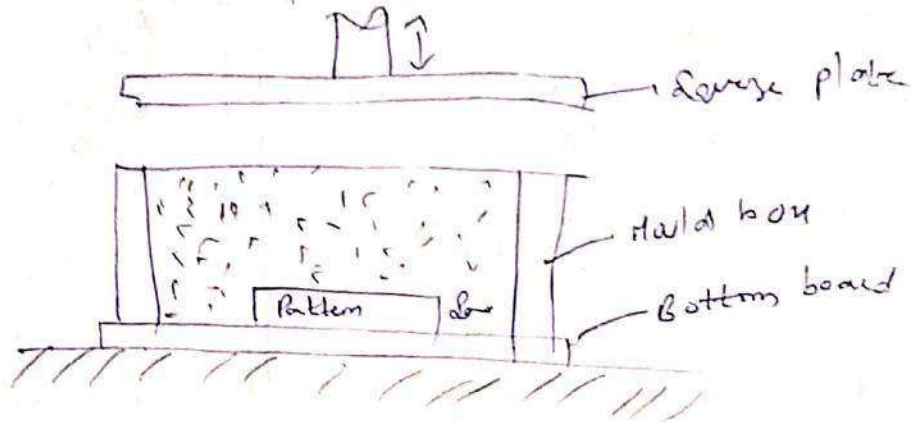

### Sand slinger:-

A sand slinger is an automatic machine equipped with a unit that throws sand rapidly and with great force into the mould box. It consists of a rigid base, sand bin, bucket elevator, belt conveyor, ramming head and a swinging arm.

In operation the pre-mixed sand mixture from the sand bin is picked by the bucket elevator and is dropped on the ~~rod~~ to the belt conveyor.

The conveyor carries the sand to the ramming head inside which there is a rotating impeller having cup shaped blades rotating at high speed.

The force of the rotor blades imparts velocity to the sand particles and as a result the sand is thrown with very high velocity into the mould box thereby filling & ramming the sand at the same time.

The density of the rammed sand can be controlled by varying the



Speed of the impeller - Rest of the operations  
 removal of pattern, gates etc, are done manually

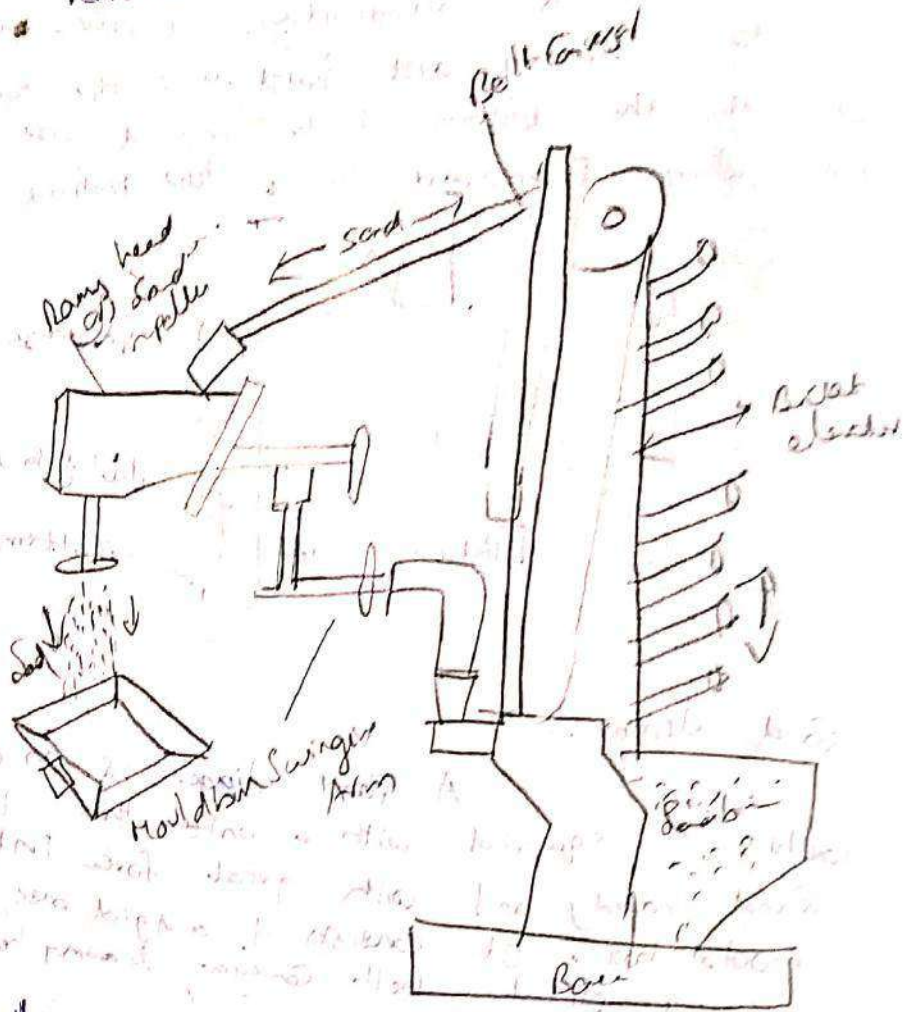

**Gating System:-**

The passage way in the mould meant for carrying molten metal to the mould cavity is known as gating system.

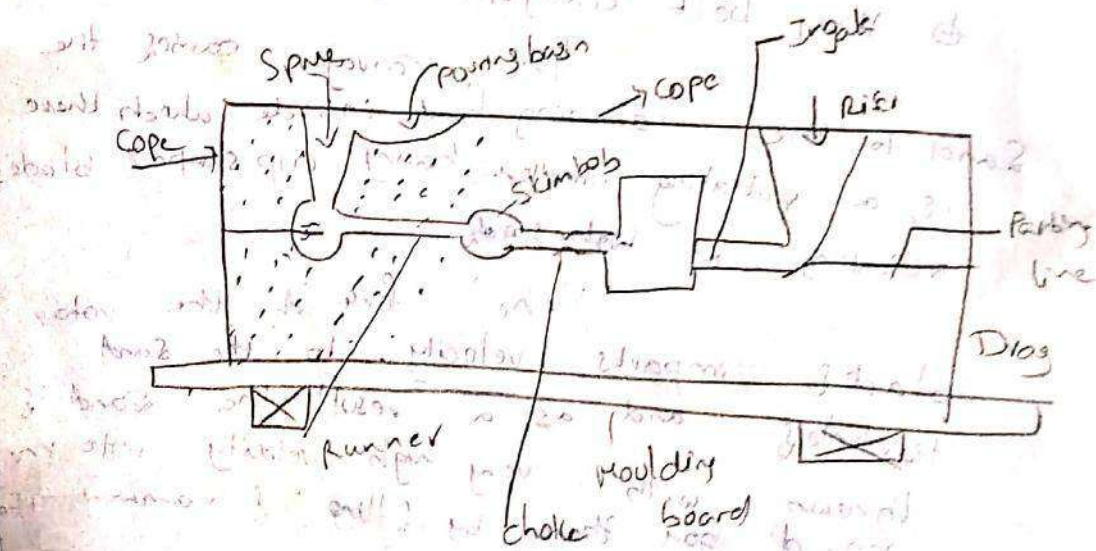

① Pouring basin:- The molten metal from the ladle is poured into the pouring basin from where it moves into the sprue and through the runner to other areas.

② Sprue:- The vertical passage way through which the molten metal flows down from a pouring plane is called sprue.

It is connected to the mould's cavity by a gate or series of gates.

The function of the sprue is to provide an entrance to mould cavity for the molten metal.

③ Sprue base or well:- At the bottom of the sprue is a reservoir for molten metal called sprue well. It serves to dissipate the kinetic energy of the falling stream of molten metal. The molten metal then changes direction and flows into the runner.

④ Runner:- It is generally located in the horizontal plane which connects the sprue to its ingates, thus letting the metal enter the mould cavity. The runners are normally made trapezoidal in cross section.

⑤ Skim bob:- It is an enlargement along the runner whose function is to trap heavier and lighter impurities such as dross or eroded sand. It thus prevents these impurities from going into mould cavity.

Gates:- These are also called the ingates, are the openings through which the molten metal enters the mould cavity.

Gates depending on their position may be top, parting, bottom type and step gate.

① Top gate: - Top gates are usually limited to small and simple mould or large castings made in moulds of erosion resistant material. It is not advisable for light and oxidizable metals like aluminium & magnesium because of fear of entrainment due to turbulent pouring.

② Parting gate: - As the name implies the metal enters the mold at the parting plane which is part of the casting in the cope and part in the drag, for the mold cavity in the drag it is a top gate and for the cavity in the cope it is a bottom gate. This is widely used.

③ Bottom gate: - The molten metal flows down the bottom of the mold cavity in the drag and enters at the bottom of the casting and rises in the mould & around the core.

On bottom gating directional solidification is difficult to achieve because the metal continues to lose its heat into the mold cavity and when it reaches the riser, metal becomes much cooler.

④ Step gate: - The metal enters mold cavity through a no. of ingates which are arranged in vertical step.

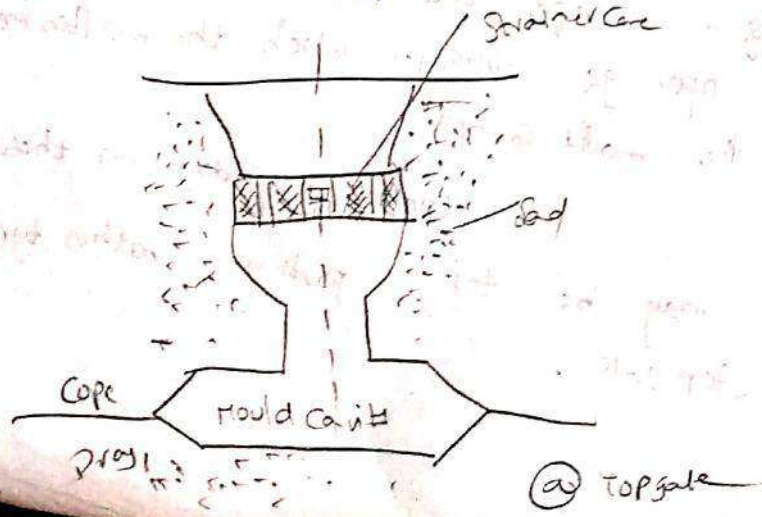

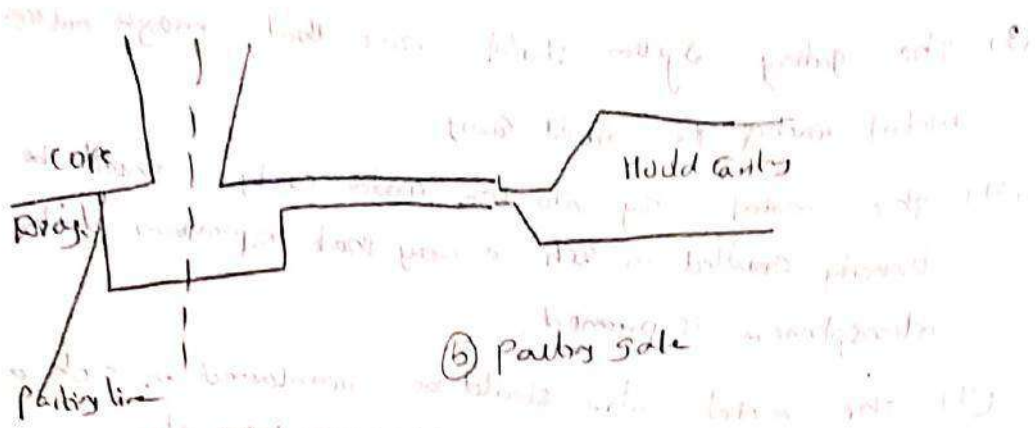

(b) Parting gate

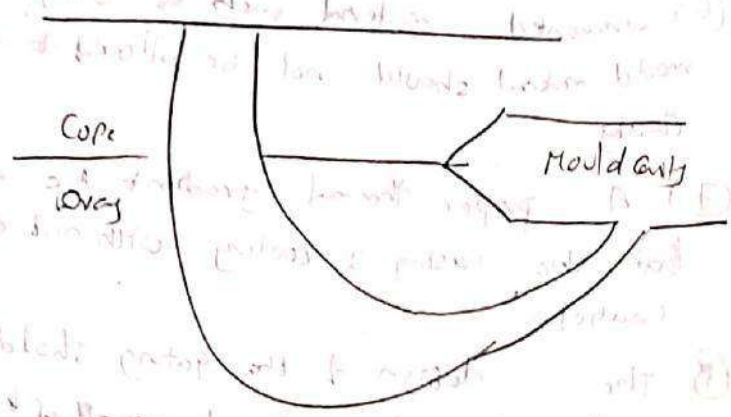

fig. Bottom gate

**Gate ratio:** It is defined as the ratio of sprue area to total runner area to total gate area.

**Sprue area:**  $\frac{\text{Runner area}}{\text{Gate area}}$

**Riser:** Riser are reservoirs designed and located to feed molten metal to the solidifying casting to compensate for solidification shrinkage. Riser is a hole cut or moulded in the cope to permit the molten metal to rise above the highest point in the casting. It provides a visual check to ensure filling up of mould cavity.

**Design requirements of the gating system:** Any gating system should aim at providing a defect free casting.

- (1) The metal should flow smoothly into the mould with out any turbulence.
- (2) The mould should be completely filled in the shortest time possible with out having to raise metal temperature or use higher metal head.

- (3) The gating system should ensure that enough molten metal reaches the mould cavity
  - (4) The metal entry into the mould cavity should be properly controlled in such a way that aspiration of the atmospheric air is prevented.
  - (5) The metal flow should be maintained in such a way that no gating or mould erosion takes place.
  - (6) Unwanted material such as slag, dross and other mould material should not be allowed to enter the mould cavity.
  - (7) A proper thermal gradient be maintained so that the casting is cooling without any shrinkage & cavities.
- (B) The design of the gating should be economical and easy to implement and removal of the casting solidification

Riser Design:-

If during casting no riser is provided, the solidification will start from walls and liquid metal in the centre will be surrounded by a solidified shell and the contracting liquid will produce voids towards the centre of the casting. Further cooling of the solid in centre sets up undesirable stresses in the casting.

The above problems are overcome by the provision of risers as these supply molten metal for a solidifying casting. To accomplish this, the risers must be large enough to remain liquid after the casting has solidified and must contain sufficient metal to provide for the contraction losses. Further, these should be so positioned that they continue to supply metal throughout the solidification period.

The risers should lose heat at a slower rate, since they are designed to solidify last as to be able to feed (enough metal) to heavy sections of the casting to make up for

shrinkage before and during solidification.

The riser size for a given casting can be obtained from the following relations:

① Chvorinov's rule - Chvorinov's rule for metal casting

states that total freezing (solidification) time for a casting is a function of the ratio of volume to surface area.

$$\text{Solidification time, } t = C \left[ \frac{\text{Volume (V)}}{\text{Surface area (A)}} \right]^2 \text{ i.e.,}$$

$$t = C \left( \frac{V}{A} \right)^2$$

where  $C =$  A constant that reflects mould material properties like latent heat & temperature.

Best riser is one whose  $\left( \frac{V}{A} \right)^2$  is 10-15% larger than that of the casting.

Since  $V$  and  $A$  for the casting are known,  $\left( \frac{V}{A} \right)^2_{\text{riser}}$  can be determined.

This rule helps in determining the solidification time of casting.   
 Limitations: Chvorinov's rule is not very accurate, since it does not take into account the solidification shrinkage. This method is valid for calculating proper riser size for short freezing range alloys such as steel and pure metals.

② Caine's method - This method of determining riser size is based on experimentally determined hydraulic relationship b/w relative freezing times and volumes of casting and the riser.

According to Caine, if the casting solidifies infinitely rapidly, the feeder (riser) volume should be equal to the solidification shrinkage of the casting, and if the feeder and casting solidify at the same rate, the feeder should be infinitely large.

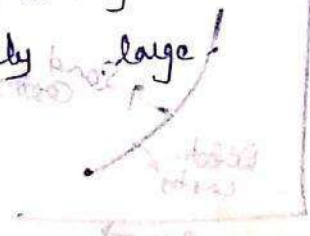

Relative freezing time or freezing ratio ( $R_f$ ) is defined as:

$$R_f = \frac{(A/V)_{\text{casting}}}{(A/V)_{\text{riser}}}$$

volume ratio ( $R_v$ ) is given as:

$$R_v = \frac{V_{\text{riser}}}{V_{\text{casting}}}$$

Then,

Caine's formula is given as  $R_f = \frac{a}{R_v - b} + c$

where

$a$  = freezing characteristic constant for the metal

$b$  = contraction ratio from liquid to solid

$c$  = relative freezing rate of riser and casting.

Typical values of  $a, b, c$  for commonly used metals are given below:

S.No	Cast-metals	a	b	c
1.	Grey Cast-iron	0.33	0.03	1.00
2.	Cast-iron, brass	0.04	0.03	1.00
3.	Steel	0.12	0.05	1.00
4.	Aluminium	0.10	0.06	1.00
5.	Aluminium bronze	0.24	0.17	1.00
6.	Silicon bronze	0.24	0.17	1.00

for determining the riser size for a given casting the diameter and height of the riser are assumed. Then known values of  $a, b, c$  the values of  $R_f$  and  $R_v$  are calculated and plotted as hyperbolic curve figure. In case the values of  $R_f$  and  $R_v$  meet the above curve, then assumed riser size is satisfactory otherwise a new assumption is made.

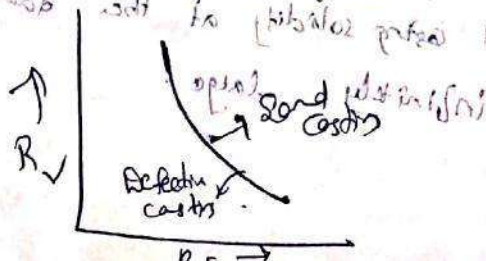

What will be the solidification time for a 1100 mm diameter and 33 mm thick casting of aluminium if the mould constant is 2.2 sec/mm<sup>2</sup>?

Sol: Diameter of casting,  $d = 1100 \text{ mm}$   
 Height / thickness of casting  $h = 33 \text{ mm}$   
 Mould constant,  $C = 2.2 \text{ sec/mm}^2$

Solidification time  $t$ :

$$\text{Volume of the casting, } V = \frac{\pi}{4} d^2 \times h$$

$$= \frac{\pi}{4} \times (1100)^2 \times 33$$

$$\text{Surface area of the casting } A = 2 \times \frac{\pi}{4} d^2$$

$$= 2 \times \frac{\pi}{4} (1100)^2$$

$$t = C \left( \frac{V}{A} \right)^2 = 1,900,663 \text{ mm}^2$$

$$= 2.2 \times \left( \frac{31,360,948}{1,900,663} \right)^2$$

$$= 598.95 \text{ sec} \approx 9.98 \text{ min}$$

Q2) Two castings of the same metal have the same surface area. One casting is in the form of a sphere and other is a cube. What is the ratio of solidification time of sphere to that of a cube.

Let  $V$  = volume of casting,  $A$  = surface area of casting

$$A_{\text{sphere}} = A_{\text{cube}}$$

According to Chvorinov's rule  
 Solidification time,  $t \propto \left( \frac{V}{A} \right)^2$

$\therefore$  Ratio of solidification time for the sphere to that of cube

$$\frac{t_{\text{sphere}}}{t_{\text{cube}}} = \left( \frac{V_{\text{sphere}}}{A_{\text{cube}}} \right)^2$$

$$= \left[ \frac{\frac{4}{3} \pi R^3}{a^3} \right]^2 = \frac{16\pi^2 R^6}{9a^6}$$



## Gating System Design

The liquid metal that runs through the various channels in the mould obeys Bernoulli's theorem which states that the total energy head remains constant at any section. The same stated in the equation form ignoring frictional losses is

$$P + \frac{\rho v^2}{2} + \rho gh = \text{constant}$$

where  $h$  = potential head,  $m$   
 $P$  = pressure,  $Pa$ ,  $v$  = liquid velocity,  $m/s$ .  $\rho$  = specific weight of liquid,  $N/m^3$ ,  $g$  = gravitational constant.

Though quantitatively Bernoulli's theorem may not be applied, it helps to understand the metal flow in the sand mould qualitatively.

As the metal enters the pouring basin, it has the highest potential energy with no kinetic or pressure energies. But as the metal moves through the gating system, a loss of energy occurs because of the friction between the molten metal and the mould walls. Also, heat is continuously lost through the mould material. Though it is not represented in the Bernoulli's equation, this lets the casting solidify.

## Another law of fluid mechanics

which is useful in understanding the gating system behaviour is the law of continuity, which says that the volume of metal flowing at any section in the mould is constant.

$$Q = A_1 v_1 = A_2 v_2$$

where  $Q$  = rate of flow,  $m^3/s$ .  
 $A$  = area of cross section  $m^2$ .  
 $v$  = velocity of metal flow,  $m/s$ .

Spines are tapered to reduce the aspiration of air due to the increased velocity as the metal flows down the spine.

## Pouring Time

The gating system design is to fill the mould in the smallest time. The time for complete filling of a mould termed pouring time, is a very important criterion for design. Too long a pouring time requires a higher pouring temp and too long a pouring time means turbulent flow in the mould which makes the casting defect-prone.

The pouring time depends on the Casting materials, complexity of the casting, section thickness and Casting size. The general considerations for choosing pouring time for grey cast iron may not be much relevant for steels since they lose heat very fast and therefore, their pouring time should be very less. For non-ferrous materials, a longer pouring time would be beneficial since they lose heat slowly.

Since the thickness of casting is effected to a great extent by the ratio of Surface area to volume of the casting it is an important variable in calculating the optimum pouring time in addition to the mass of the casting itself. Normally while considering the mass of the casting it may not be necessary to consider the mass of the gating system because the gating system is completely filled with metal before entering the mold cavity.

The following are some standard parameters:

① Grey Cast Iron, Mass less than 450 kg.  
 Pouring time  $t = K \left( 1.41 + \frac{T}{14.59} \right) \sqrt{W}$  s  
 where  $K =$  fluidity of iron in inches  
 $T =$  average section thickness, mm  
 $W =$  mass of the casting, kg

② High strength Cast Iron, Mass greater than 450 kg  
 Pouring time  $t = K \left( 1.236 + \frac{T}{16.65} \right) \sqrt{W}$  s  
 Typical pouring times for cast iron are as follows:  
 Casting mass: 20 to 100 kg, 15 to 30  
 Pouring time: 6 to 10 s

③ Steel castings  
 Pouring time,  $t = (2.4335 - 0.395) \log W \sqrt{W}$  s  
 where  $W =$  casting mass in kg  
 For thin sections  $t = 2.080 \sqrt{W}$   
 For sections 10 to 25 mm  $t = 2.670 \sqrt{W}$   
 For header section  $t = 2.920 \sqrt{W}$

5) Copper alloy castings

Pouring time,  $t = k_2 \sqrt[3]{W}$  s

$k_2$  is a constant given by

Top gating	1.30
Bottom gating	1.80
Brass	1.90
Tin bronze	2.80

6) Indispensably tapered thin-walled castings of mass up to 400 kg

Pouring time,  $t = k_3 \sqrt[3]{W}$  s

where  $W$  = mass of the casting with gates and risers, kg, and  $k_3$  = a constant as given below

Outside diameter $T$ (mm)	$k_3$
1.5 to 2.5	1.62
2.5 to 3.5	1.68
3.5 to 8.0	1.85
8.0 to 15.0	2.20

7) For other castings greater than 450 kg and up to 1000 kg

Pouring time,  $t = k_4 \sqrt[3]{W \cdot T}$  s

where  $k_4$  is a constant given by

$T$ (mm)	$k_4$
up to 200	1.35
200 to 400	1.50
above 400	1.70

① Calculate the optimum pouring time for a casting whose mould is 20g and having an average thickness of 15 mm. The materials of the casting are grey cast iron and steel. Take the fluidity of iron as 28 inches.

Grey Cast Iron

$$\text{Pouring time, } t = K \left( 1.41 + \frac{T}{14.59} \right) \sqrt{W}$$

where  $K = \frac{\text{fluidity of iron in inches}}{40} = \frac{28}{40}$

$$t = \left( 1.41 + \frac{15}{14.59} \right) \sqrt{20} = 7.6325$$

Steel = Pouring time  $t = (2.4335 - 0.3953 \log W) \sqrt{W}$

$$= (2.4335 - 0.3953 \log 20) \sqrt{20} = 8.5825 \text{ s}$$

### Methods of Melting:-

Melting Equipment:- The main types of furnaces used in foundries for melting various varieties of ferrous and non-ferrous metals and alloys are

- ① Crucible furnace
- ② Air furnace
- ③ Cupola furnace
- ④ Blast furnace
- ⑤ open hearth furnace
- ⑥ electric furnace

#### ① Crucible furnace:-

A crucible furnace is most suited for small foundries and can be designed for melting any of the metals. It consists of the following two main types:

- ① Pit type furnace
- ② tilting type furnace

#### ① pit type crucible furnace:-

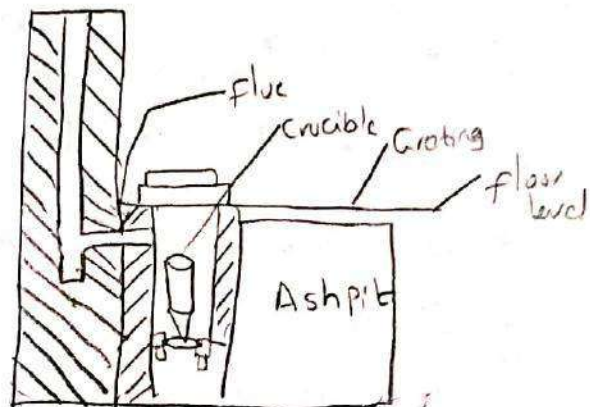

a) It is built to suit the type of metal to be melted.  
 b) These are fixed wholly or partly in the ground from which the crucible must be lifted when the metal is ready.  
 → Hence a crucible (a heat resisting pot for metal melting and made of fire clay mixed with coke dust or graphite) is placed in a pit in the floor. The furnace is usually fired with sufficient coke being packed around and above the crucible pots to melt and superheat the charge with out re-cooking. The natural draught provided by tall chimney is controlled by means of loose brick or damper at the foot of the stack.

② Tilting type crucible furnace:-

1. This type of furnace is built above the ground level and contains a firmly fixed crucible.
2. The furnace is fired with coke, oil or gas and the forced draught is used.
3. When the metal charge is ready for pouring the whole furnace is tilted and the crucible emptied by operating a geared arrangement.

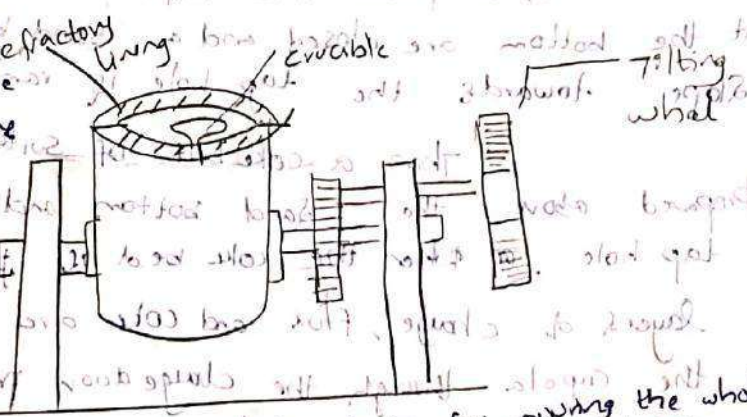

a. for the metals of high melting points clay crucible are used; for the low melting-point metals such as zinc-base or aluminium cast iron or steel crucibles are suitable to be used.

② Cupola furnace:-

A cupola consists of a cylindrical shell with its interior lined with heat-resistant bricks. It consists of drop doors at the bottom after closing which a proper sand bed could be prepared. This sand bed provides the necessary refractory bottom for the molten metal and the coke. Immediately above the sand bed is the metal tapping hole which is initially closed with clay called 'bot' till the molten metal is ready for tapping. Above the metal tap hole, normally in a position opposite to it is the slag hole, through which the slag generated during the melting process is tapped.

Above the slag hole is the wind box which is connected to the air blower supplying the requisite air at a given pressure. The air enters the cupola through the tuyeres. A little above the charge platform of the charging hole in the shell, from where the charge consisting of a combination of pig iron, scrap iron, coke and flux is put into the cupola, the refractory lining above the charge door need not necessarily be as thick as that below, since it is not exposed to much heat.

Working. → To operate the cupola, first, the drop doors at the bottom are closed and a sand bed with a gentle slope towards the tap hole is rammed.

Then a coke bed of suitable height is prepared above the sand bottom and ignited through the tap hole. As soon as the coke bed is properly ignited, alternate layers of charge, flux and coke are alternately fed into the cupola through the charge door maintaining the necessary proportions and rate of charging.

The charge is then allowed to soak in the heat for a while, and then the air blast is turned on. With 10 to 15 min, the molten metal is collected near the tap hole. When enough molten metal is collected in the well of the cupola, the slag is decanted off through the slag hole before opening the tap hole. The molten metal is collected in the ladle and then transported to the moulds into which it is poured.

with a minimum time loss. The charge needed to produce cast iron essentially consists of pig iron, cast iron, scrap and steel scrap. The proportions of these depends on their chemical composition and the final chemical composition of cast iron desired.

The fluxes are added in the charge to remove oxides and other impurities present in the metal. The flux most commonly used is  $\text{CaCO}_3$  in a proportion of about 2 to 4%. Other fluxes used are dolomite, sodium carbonate and calcium carbide.

The fluxes are added in the charge to remove oxides and other impurities present in the metal. The flux most commonly used is  $\text{CaCO}_3$  in a proportion of about 2 to 4%. Other fluxes used are dolomite, sodium carbonate and calcium carbide.

## Special Casting processes

① Shell Moulding - It is a process in which the sand mixed with a thermosetting resin is allowed to come into contact with a heated metallic-pattern plate, so that a thin & strong shell of mould is formed around the pattern.

Generally dry and fine sand that is completely free of clay is used for preparing the shell-moulding sand. The grain size to be chosen depends on the surface finish desired on the casting.

The synthetic resins used in this are thermosetting resins which get hardened irreversibly by heat. The resins most widely used are the phenol formaldehyde resins, these phenolic resins used in shell moulding usually are of 2-stage type, that is the resin has small phenol & acts as like a thermoplastic material. During coating with the sand, the resin is combined with a catalyst such as hexamethylene-tetramine in a proportion of 14-16% to develop thermosetting characteristics.

Additives may be added into the sand mixture to improve surface finish and avoid thermal cracking during pouring. Some are manganese dioxide, coal dust etc.

Steps - ① The first step is preparing the shell mould i.e. the preparation of the sand mixture in such a way that each of the sand grains is thoroughly coated with resin. To achieve this first the sand, hexa and additive which are all dry are mixed inside a muller for a period of 1 min.

② Then the liquid resin is added and mixing is continued for another 3 min. To this warm air is introduced into the muller and mixing is continued till all the liquid is removed from the mixture.

The sand-resin mixture is to be cured at about  $150^{\circ}\text{C}$  temp. & the metallic pattern plate is heated to a temp of  $200-350^{\circ}\text{C}$  depending on the type of pattern. It is very essential that the pattern plate is uniformly heated. The heated pattern is securely fixed to a dump box as shown in fig (a) where in the cooled sand in an amount larger than required to form the shell of necessary thickness.



So that the coated sand falls on the heated pattern. The heat from the pattern melts the resin adjacent to it.

When the desired thickness of shell is achieved, the dump box is rotated backwards by  $180^\circ$  so that excess sand falls back into the box, leaving the formed shell intact with the pattern. The only shell thickness depends on the temp of pattern, and the time the coated sand remains in contact with the heated pattern.

The shell along with the pattern plate is kept in an electric furnace for curing the shell.

**Adv:-**  
= ① Shell-mold castings are generally dimensionally more accurate than sand castings.

② A smoother surface can be obtained in shell castings.

③ Draft angles which are lower than the sand castings are required in shell molds. The restriction in draft angles may be from  $30^\circ$  to  $75^\circ$ , which saves the material costs.

④ Also very thin sections up to  $0.25\text{mm}$  of type of air-cooled cylinder heads can be readily made by the shell molding because of higher strength.

⑤ Very small amount of sand needs to be used.

### Limitations

① The patterns are very expensive and therefore are economical only if used in large-scale production.

② The size of the casting obtained by shell molding is limited.

③ Highly compacted shape cannot be obtained.

## Applications:-

① Cylinder and cylinder heads for air-cooled B. engines  
automobile transmission parts, brake beam, steel eyes, gear blanks,  
Small crank shafts, radone hubs etc,

## ② Continuous casting:-

Continuous casting, also referred to as strand casting, is a process used in manufacturing industry to cast a continuous length of metal (or) produces higher quality steels for less cost.

It involves the following steps:-

① The molten metal in the ladle is cleaned and equalised temperature by blowing nitrogen gas through it for 5 to 10 minutes.

② The metal is then poured into a refractory lined intermediate pouring vessel called tundish. It holds the liquid metal for casting.

The tundish holds as 3 tonnes of metal. This is placed about 80-90 feet above the ground level.

③ The molten metal travels through water-cooled copper moulds and begins to solidify as it travels downward along a path supported by rollers (pinch rolls).

④ Before the casting process is started a solid starter or dummy bar is inserted into the bottom of the mould. The molten metal is then poured and solidifies on the starter bar. The bar is withdrawn at the same rate the metal is poured. The cooling rate is such that the metal develops a solidified shell to support itself during its travel downwards at a typically of 25 mm/s. The shell thickness is about 12 to 18 mm. The moulds are generally coated with graphite to reduce friction.

⑤ The continuously cast metal may be cut into desired lengths by torch cutting or shearing, or it may be fed directly into a rolling mill for further reductions in thickness and for shape rolling of products such as channels and I-beams.

⑥ The metal casting moves outside the mould with the help of different sets of rollers.

⑦ while one set of rollers bend the metal cast, another set will straighten it.

⑧ This helps to change the direction of flow of the steel slab from vertical to horizontal.

Adv:-

① The process is cheaper than rolling.

② Labour cost is less.

③ Casting surface structure of the casting can

④ Grain size and structure of the casting can

be easily controlled.

Dis:- ① continuous and capable cooling of mould is required

② Just simple shapes can be cast.

③ Capital investment is necessary to set up process.

④ Not proper for small scale production.

⑤ Require large ground space.

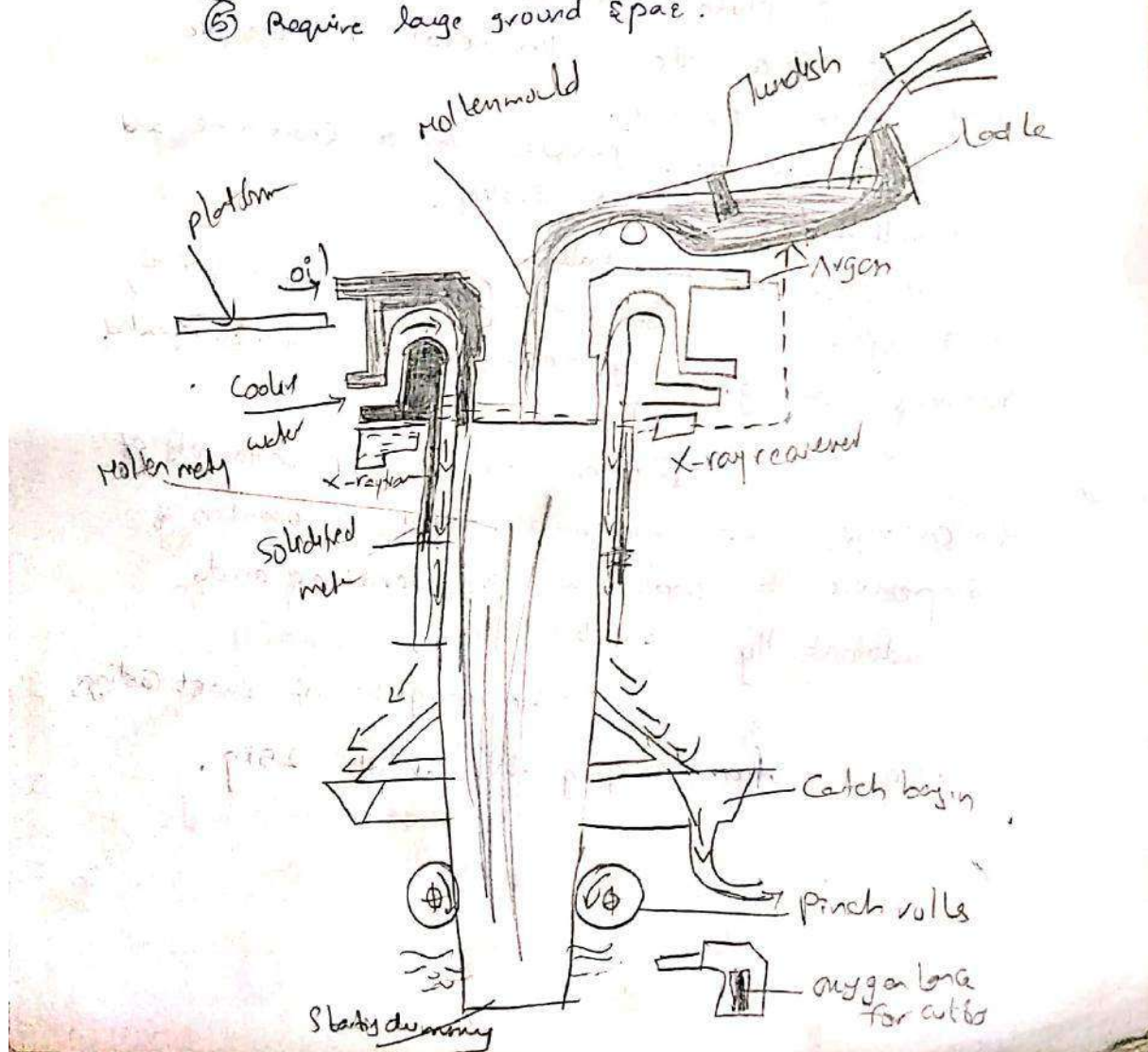

## ② Die-casting:-

Die-casting or pressure Die Casting is essentially permanent mould casting in which pressure forces the molten metal into the mould cavity. However, the mould used is much more expensive (called die) and a complex machine is employed to produce casting at a very high rate.

If the molten metal is forced into a metallic die under a gravity head the process is known as "Gravity die casting" or "permanent mould casting".

The mould is normally called a metallic die with two halves. one half is fixed and the other is movable.

Die materials like medium carbon, low alloys, hot steels are used.

In die casting the following steps are involved:-

- ① close and lock the two halves of the die.
- ② force the molten metal into the die cavity under pressure.
- ③ Maintain the pressure for a short time and permitting the metal to solidify.
- ④ Open the die halves.
- ⑤ Eject the casting with its assembly of sprue, runners and gates by pins. The above cycle is repeated.

In order to obtain uniformity of die castings and maximum speed of operation is imperative to employ a predetermined and automatically controlled cycle.

The weight of most castings range from 90g to about 25kg.

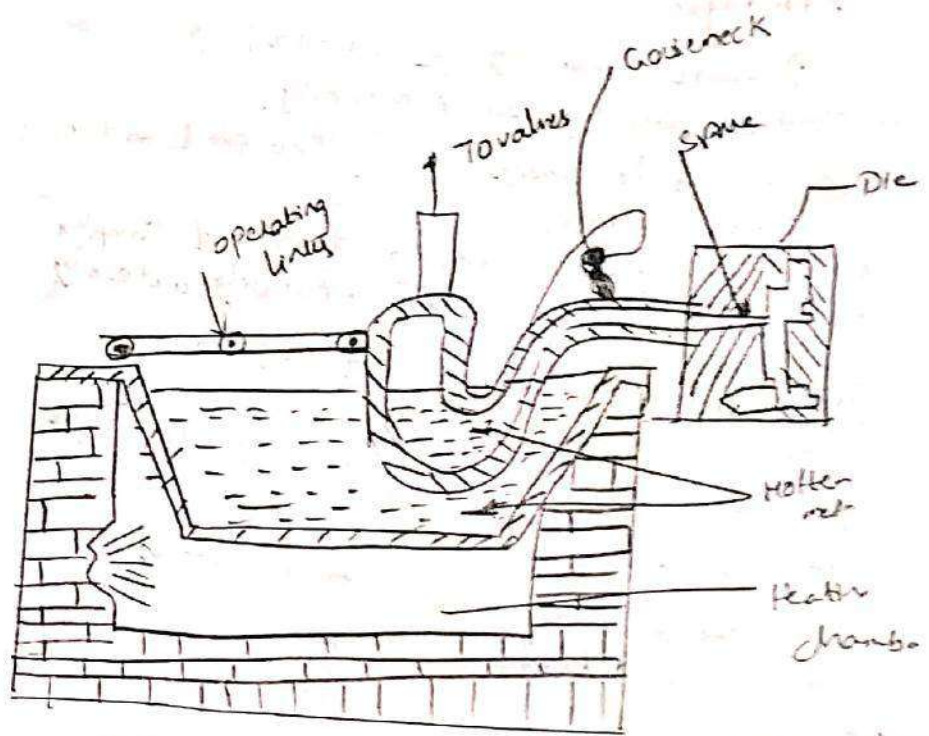

following are the 2 types of die-casting Processes-

- ① Hot-chamber process    ② Cold-chamber process.

① **Hot-chamber process:** This process involves the use of piston, which traps a certain volume of molten metal and forces it into the die cavity through a gooseneck and nozzle. The pressure ranges up to 35 MPa with an average of about 15 MPa. The metal is held under pressure until it solidifies in the die.

Low melting point alloys such as zinc, tin & lead are commonly used.

② **Cold-chamber process:** In this process, molten metal is introduced into the injection cylinder (shot chamber). The shot chamber is not heated, hence the term cold chamber. The metal is forced into the die cavity at pressures usually ranging from 20 to 70 MPa, although it may be high as 150 MPa.

The machinery may be horizontal or vertical.

High-melting point alloys of aluminium, magnesium & copper are normally cast by this method.

### Advantages:-

- ① Large quantities of identical parts can be produced rapidly and economically.
- ② very little machining is required on the parts produced.
- ③ The parts having thin and complex shapes can be casted accurately and easily.
- ④ The castings produced by this are less defective.
- ⑤ The rapid cooling rate produces high strength and quality in many alloys.
- ⑥ Cored holes down to 0.75 mm dia at accurate locations are possible.
- ⑦ The sprue, runners and gates can be rerilled resulting in low scrap loss.
- ⑧ The die casting requires less floor area than other casting processes.

### Disadvantages:-

- ① The cost of equipment & dies is high.
- ② There is a limited range of non-ferrous alloys which can be used for die casting.
- ③ The die castings are limited in size.
- ④ It requires special skill in maintenance.
- ⑤ It contains some porosity due to entrapment of air.

### Applications:-

- ① Transmission housings
- ② Valve bodies
- ③ Carburetors
- ④ Hand tools
- ⑤ Toys
- ⑥ Motors etc.

## Centrifugal Casting

This is a process where the mould is rotated rapidly about its central axis as the metal is poured into it. Because of the centrifugal force, a continuous pressure will be acting on the metal as it solidifies. The slag, oxides and other inclusions being lighter, get separated from the metal and segregates toward the centre.

There are 3 types of Centrifugal casting. They are

- ① True centrifugal casting
  - ② Semicentrifugal casting
  - ③ Centrifuging
- ① True centrifugal casting:- This is normally used for the making of hollow pipes, tubes, hollow bushes etc, which are axis-symmetric with a concentric hole. The axis of rotation can be either horizontal or vertical or any angle in between. Very long pipes are normally cast with horizontal axis, where as short pieces are more conveniently cast with a vertical axis.

A normal centrifugal casting machine used for making cast-iron pipes in sand moulds is shown in fig. First, the moulding flask is properly rammed with sand to conform to the outer contour of the pipe to be made. Any end details such as spigot ends, or flanged ends are obtained with the help of dry sand cores located in the ends. Then the flask is dynamically balanced so as to reduce the occurrence of undesirable vibrations during the casting process. The finished flask is mounted in between the rollers and the mould is rotated slowly. Now the molten metal is requisite quantity is poured into the mould through the movable pouring basin. The amount of metal poured determines the thickness of the pipe to be cast. After the pouring is complete, the mould is rotated at its operational speed till it solidifies, to form requisite tubing.

Metal moulds can also be used in this process for large quantity production. A water jacket is provided around the mould for cooling it.

The casting machine is mounted on wheels, with the pouring ladle which has a long spout extending till the other end of the pipe is made. To start the mould is rotated with the metal being delivered at the extreme end of the pipe.

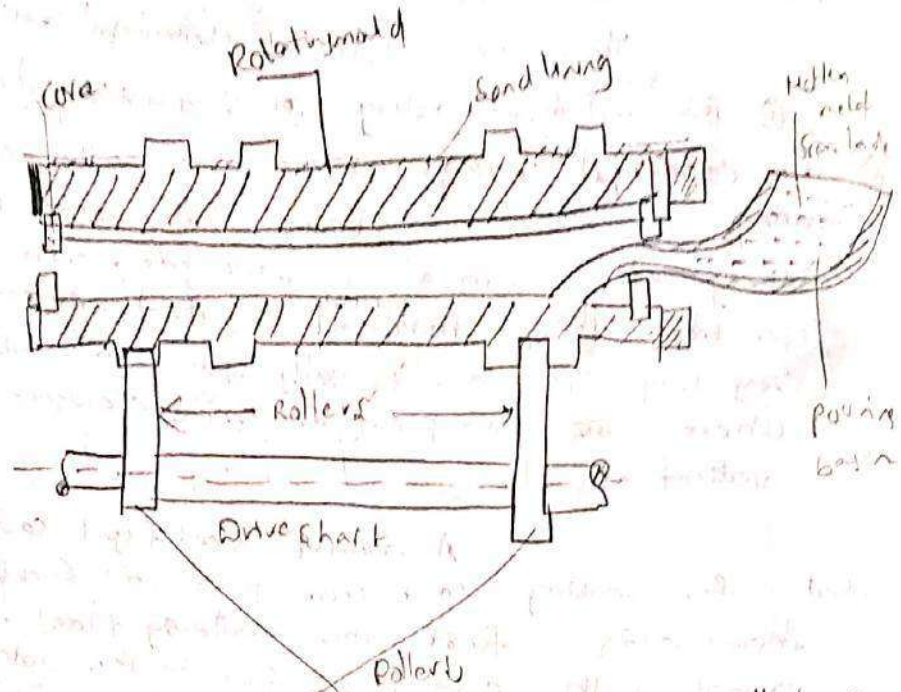

### Advantages:

= The mechanical properties of centrifugally cast jobs are better compared to other process because the inclusions such as slag and oxides get segregated towards the centre and can be easily removed by machining.

### Limitations:-

= only certain shapes which are axis symmetric and having concentric holes are suitable for the centrifugal castings.

② The equipment is expensive and thus is suitable only for large quantity production.



## ② Semi-centrifugal castings -

It is used for jobs which are more complicated than those possible in true centrifugal casting, but are axis-symmetric in nature. It is not necessary that these should have a central hole, which is to be obtained with the help of a core. The moulds made of sand or metal are rotated about a vertical axis and the metal enters the mould through the central pouring basin as shown in fig. For larger production rates, the moulds can be stacked one over the other, all feeding from the same central pouring basin. The rotating speeds used in this process are not as high as in case of true-centrifugal casting.

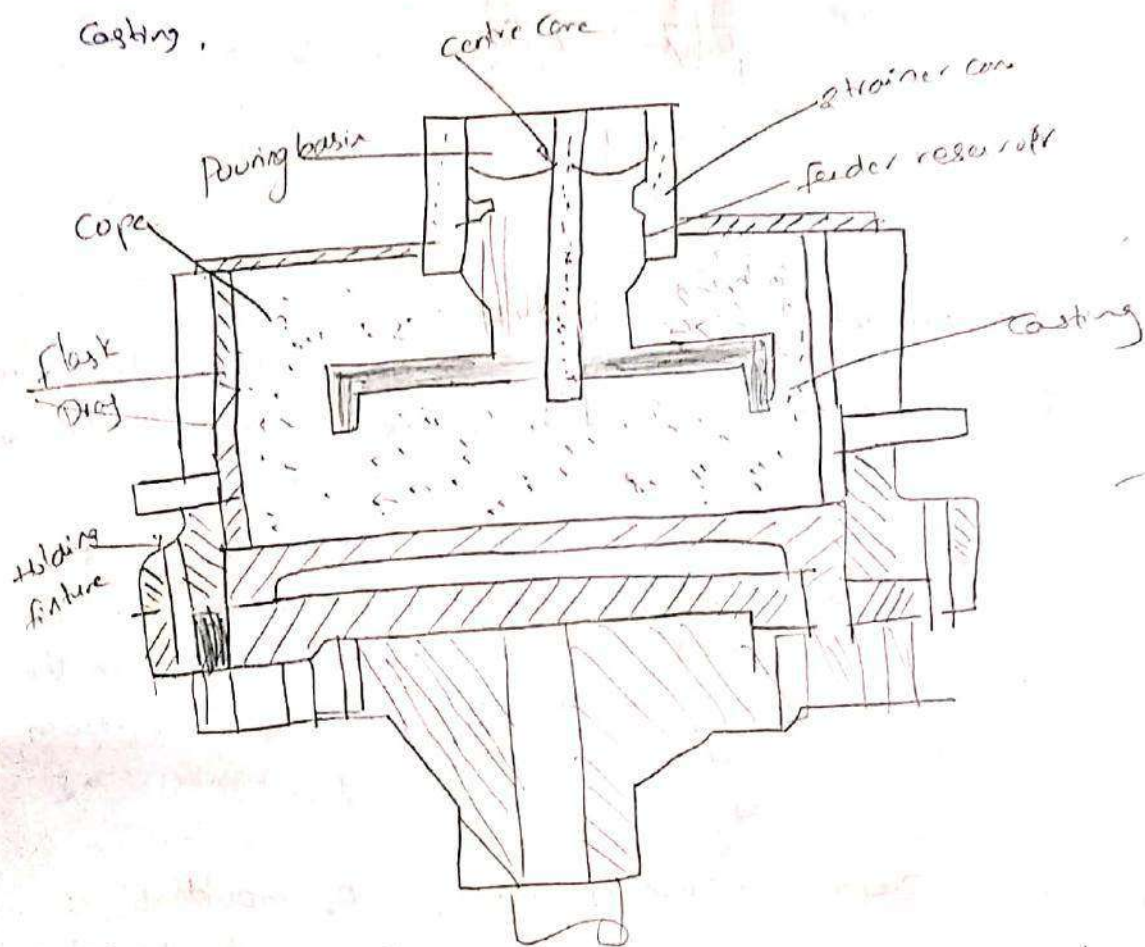

## ③ Centrifuging -

In order to obtain higher metal pressure during solidification, when casting shapes are not axis-symmetrical, the centrifuging process is used. This is suitable only for small jobs of any shape. A number of such small jobs are joined together by means of a radial runner with a central sprue in a revolving table as in fig. The jobs are uniformly placed on the table around the periphery so that their masses are

Properly balanced. The process is similar to semi centrifugal casting.

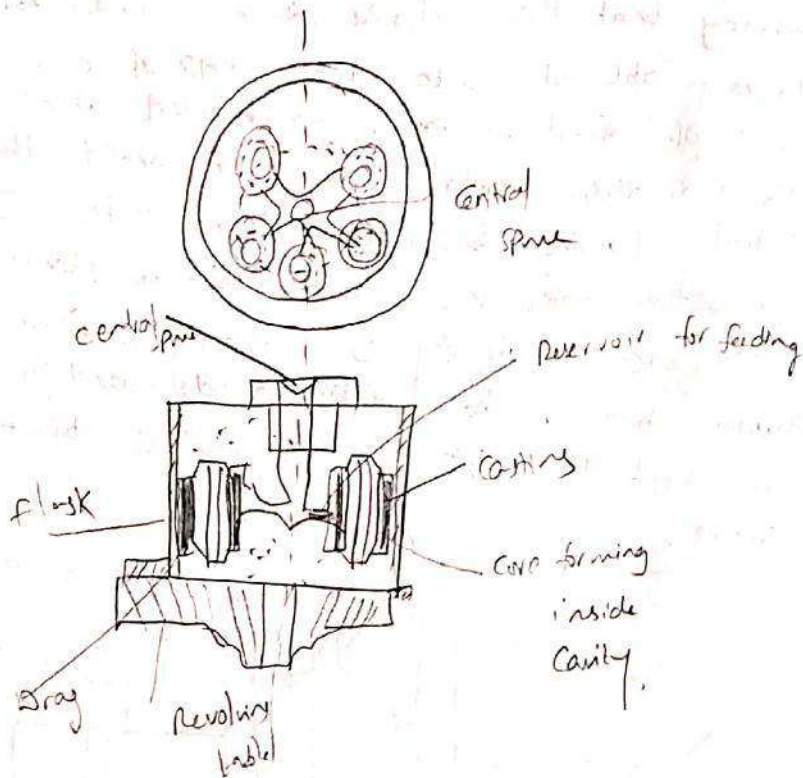

### Carbondioxide ( $CO_2$ ) moulding:-

1.  $CO_2$  moulding also known as sodium silicate process is one of the widely used process for preparing moulds and cores.
2. In this process, sodium silicate is used as the binder. But sodium silicate activates or tend to bind the sand particles only in the presence of carbondioxide gas. for this reason, the process is commonly known as  $CO_2$  process.

Steps involved in making  $CO_2$  mould:-

1. Suitable proportions of silica sand and sodium silicate binder (3-5% based on sand weight) are mixed together to prepare the sand mixture.
2. Additives like aluminium oxide, molasses etc, are added to impart favorable property and to improve collapsibility of sand.
3. The pattern is placed on a flat surface with the drag box enclosing it. Parting

Sand is sprinkled on the pattern surface to avoid sand mixture sticking to the pattern.

The drag box is filled with the sand mixture and rammed manually till its top surface. Rest of operations like placing sprue and riser pin and ramming the cope and are similar to green sand moulding process.

Fig shows the assembled cope and drag box with vent holes. At this stage, the  $CO_2$  gas is passed through the vent holes for a few rounds.

Sodium silicate reacts with  $CO_2$  gas to form silica gel that binds the sand particles together. The chemical reaction is given by:



The sprue, riser and the pattern are with drawn from the mould and gates are cut in usual manner. The mould cavity is finished and made ready for pouring.

- Adv:-
1. Instantaneous strength development. The development of strength takes place immediately after  $CO_2$  gas is completed.
  2. Since the process uses relatively safe  $CO_2$  gas, it does not pose sand disposal problems or any other while mixing and pouring. Hence the process is safe to human operators.
  3. Very little gas evolution during pouring of molten metal.

Disad:-

1. Poor collapsibility of moulds is a major disadvantage of this process. Although some additives are used to improve this property for ferrous metal casting and it cannot be used for non-ferrous applications.
2. The sand mixture has the tendency to stick to the pattern and has relatively poor flowability.
3. Overheating and underheating adversely affect properties of sand.

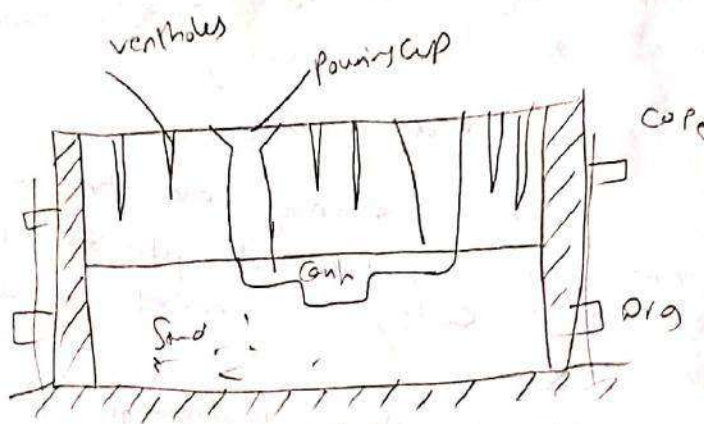
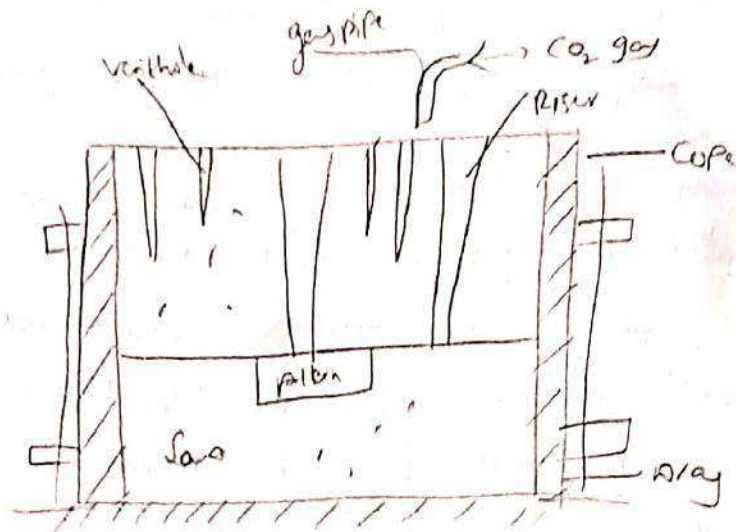

Plaster - Mould Casting:-

→ plaster - mould casting is a metal working casting process similar to sand casting except the moulding material is plaster of Paris (Gypsum - or Calcium sulphate).

→ with the addition of talc and silica flour to improve strength and to control the time required for the plaster to set. These components are mixed with water, and the resulting slurry is poured over the pattern. After the plaster sets, usually within 15 minutes, the pattern is removed and the mould is dried to remove the moisture.

The moulds are then assembled to form the mould cavity and preheated to about 120°C for 16 hours.

Next, the molten metal is poured into the mold. Because plaster moulds have very low permeability evolved during solidification of the metal cannot escape. Consequently, the molten metal is poured either in a vacuum or under pressure.

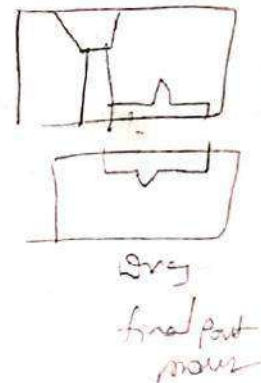
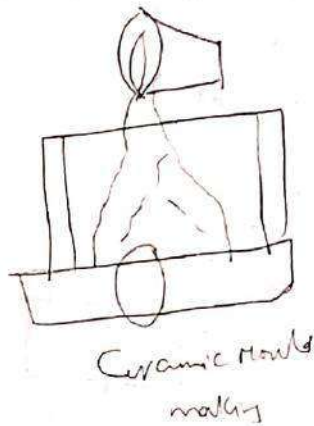
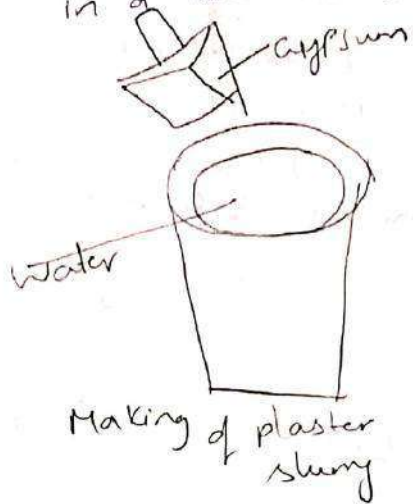

Adv:-

- ① High dimensional accuracy
- ② Smooth surface
- ③ Low porosity
- ④ Mould easily repairable.

Disadv:-

- ① Limited to non-ferrous metallic castings
- ② Dimensional castings
- ③ Time consuming.

Ceramic - mould casting:-

The ceramic mould casting is similar to the plaster mould process with the exception it uses refractory mould materials suitable for high-temp applications. This process is also called cope-cord drag investment casting.

The slurry is a mixture of fine grained zircon ( $ZrSiO_4$ ) aluminium oxide and fused silica which are mixed with bonding agents and poured over the pattern which has been placed in a flask. The pattern may be of wood or metal.

After setting the moulds (ceramic facings) are removed, dried, burned off to remove volatile matter, and baked. The moulds are clamped firmly and used as all ceramic moulds.

In shaw process, the ceramic facings are backed by firebrick to give the moulds strength. The facings are then assembled into a complete mould, ready to be poured.

The high-temp resistance of the refractory moulding materials allow these moulds to be used in casting ferrous & other high-temp alloys, stainless steels.

These castings have good dimensional accuracy and surface finish over a wide range of sizes and intricate shapes, but the process is somewhat expensive.

Typical parts made are:-

- (1) Impellers, Dies for metal working; Moulds for making plastic or rubber components etc.

### Stir casting:-

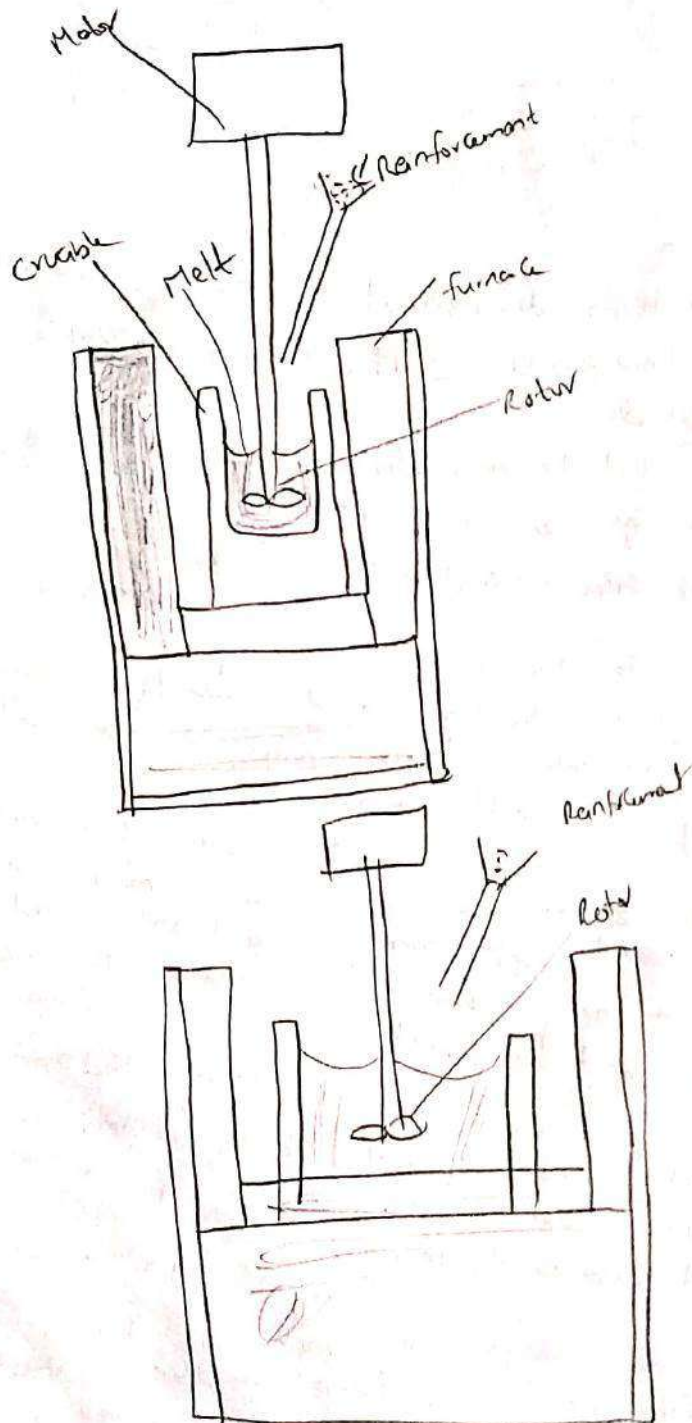



**SREENIVASA INSTITUTE OF TECHNOLOGY AND  
MANAGEMENT STUDIES**

**CHITTOOR, ANDHRA PRADESH- 517127**

**AN ISO 9001:2015 CERTIFIED INSTITUTION**

**(AUTONOMOUS and ACCREDITED BY NAAC & NBA, PERMANENTLY AFFILIATED TO JNTU ANANTHAPURAMU)**

**DEPARTMENT OF MECHANICAL ENGINEERING**

NOTES FOR

**MANUFACTURING TECHNOLOGY**

**UNIT-II**

**WELDING AND CUTTING**

## Differences

btw TIG & MIG

### TIG

- (1) Non-consumable electrode is used
- (2) Produce high quality weld
- (3) No weld cleaning is necessary
- (4) Gas used for TIG welding is argon
- (5) High skilled operator is required
- (6) Process is slow compared to other processes
- (7) It provides lower deposition rate
- (8) It is suitable for welding in all positions

### MIG

- (1) Consumable electrode is used
- (2) It does not produce high quality weld
- (3) Weld cleaning is necessary
- (4) Gas used for MIG welding is helium, oxygen, nitrogen.
- (5) High skilled operator is not required
- (6) Process is faster than TIG welds
- (7) It provides higher deposition rate
- (8) It is suitable for welding thin sheets.



Characteristics

UNI-2  
WELDING AND CUTTING

Welding

It is the method of joining metals by application of heat, with or without the use of solder or any other metal or alloy having a lower melting point than the metals being joined.

(or)  
Welding is defined as "a localized coalescence of metals, where in coalescence is obtained by heating to suitable temp, with or without the application of pressure and with or without the use of filler metal".

Classification of welding process:-

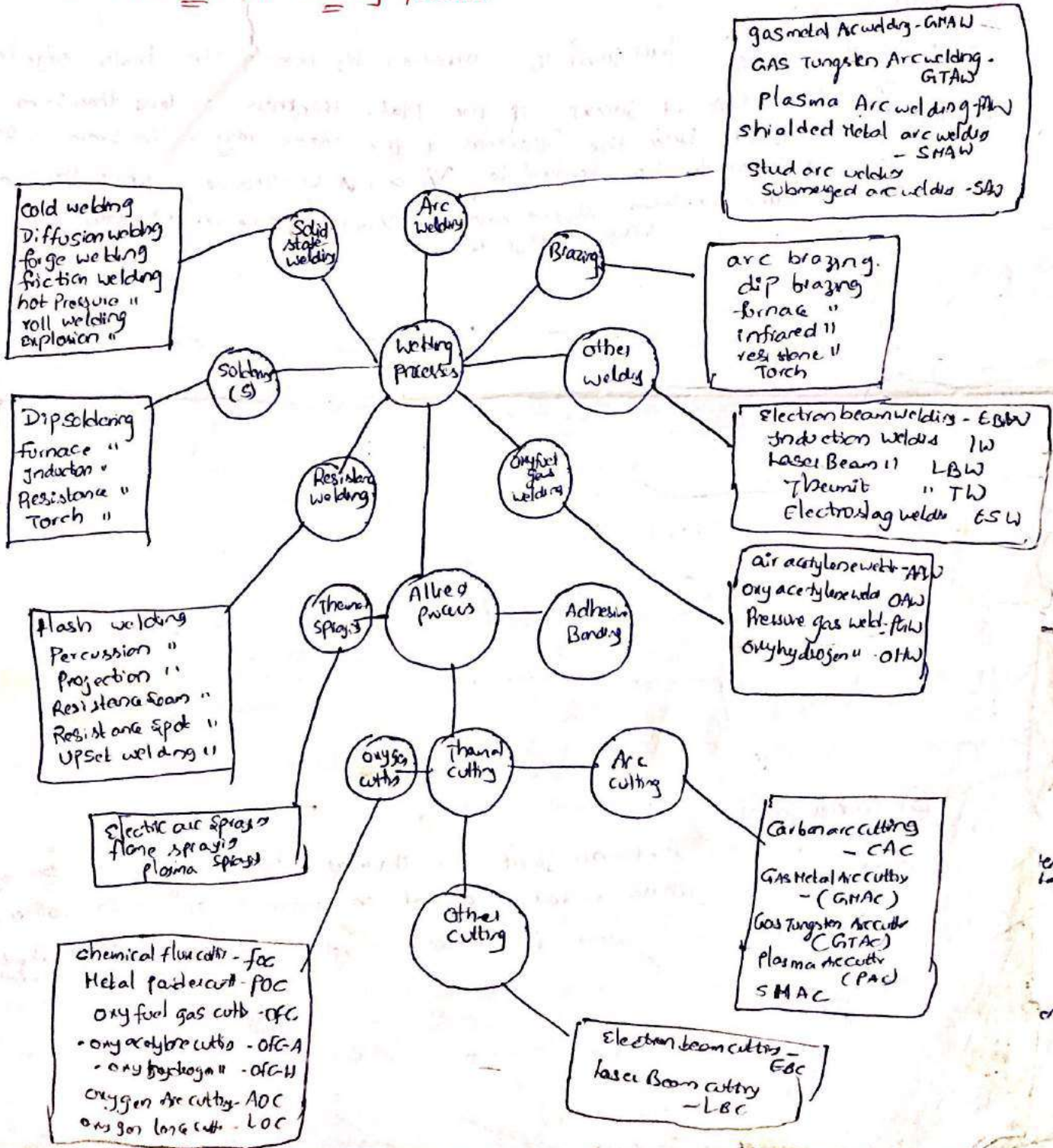

## Types of welded joints:-

- ① Lap joint:- The lap joint is obtained by overlapping and then welding the edges of the plates.
- ② The lap joint may be single traverse double traverse & partial.
- ③ These joints are employed on plates having thickness  $\leq 3$ .

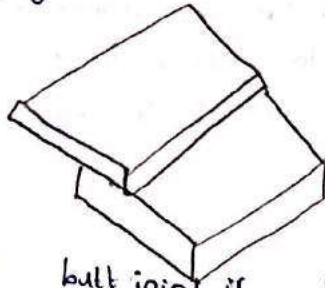

## ② Butt joints:-

The butt joint is obtained by placing the plates edge to edge as shown in fig.

In this type of joints if the plate thickness is less than 5mm beveling is not required. When the thickness of the plates ranges between 5mm-12.5mm the edge is required to be bevelled to V or U-groove, while the plates having thickness above 12.5mm should have a V or U-groove on both sides.

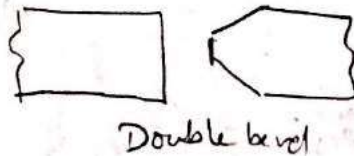
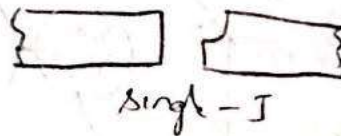
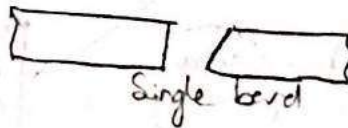
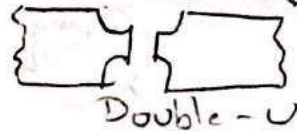
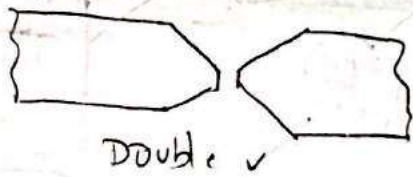
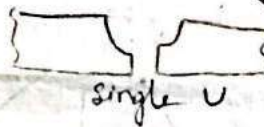
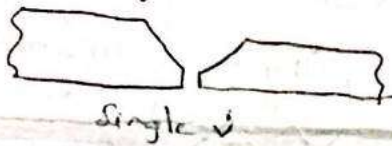

## ③ Corner joint.

two plates

- ① A corner joint is obtained by joining the edges of whose surfaces are at an angle of  $90^\circ$  to each other.
- ② It is used for both light and heavy gauge sheet metal.

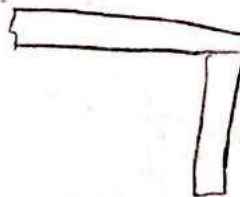

## Characteristics of weld joints:-

- A properly made weld should have the following characteristics:
- ① The weld should not crack in the hard test.
  - ② It should not contain slag imbedded in the weld.
  - ③ Its appearance should be ripple like and not spongy.
  - ④ It should not have cavities, and the grain<sup>size</sup> should be uniform.
  - ⑤ The weld should have even width.
  - ⑥ Over current tries to dissolve scum in the weld while under current tries to give cracks in the weld.
  - ⑦ If electrode distance from the weld is varying this will cause the unevenness of the weld.

## Defects in welding:-

- ① Undercut
- ② Porosity and blowholes
- ③ Slag inclusion
- ④ Cracks
- ⑤ Lamellar tearing.

① **Undercut**: - This appears like a small notch in the weld interface. This is generally attributed to the improper welding technique or excessive welding current. This is mainly caused by the incorrect manipulation of the electrode while depositing the bead, particularly in horizontal & vertical welding. It can be created by

② **Porosity**: - Porosity in welding is caused by the presence of gases which get entrapped during the solidification process. The main gases that cause porosity are Hydrogen, oxygen & Nitrogen. Hydrogen is the main cause of porosity in the weld pool. The sources of  $H_2$  could be the electrode coatings such as cellulose dissociation of water, which is present as moisture pick up of electrodes, left over wire drawing lubricant on the electrode wire.

$O_2$  generally reaches the weld pool outside of base metal or filler metal.  $N_2$  generally enters the weld pool through atmospheric nitrogen or the contaminated shielding gas.

Porosity if present in large would reduce the strength of the joint.

③ **slag inclusions**: - Inclusions are the slag or non-metallic particles and are derived from the environments around the weld metal. Basic slags are more viscous, and are more difficult to remove from the molten metal. Slow cooling of the molten weld metal pool helps in the elimination of inclusions.

The factors cause slugs are

- ① High viscosity of weld metal
- ② Rapid solidification
- ③ Insufficient welding heat
- ④ Improper manipulation of the electrode.

④

Cracks:-

In steel welds cracks are most serious defects. cracks may be formed due to various causes such as unequal physical properties of the parent and weld metals, high conditions of faulty welding.

(1) Hot crackings:- Generally occur at high temperature & size very small to visible. The crack in most parts is intergranular. magnitude depends upon the strains involved in solidification. They are more likely to form during the root pass when the mass of the metal is very large compared to weld metal deposited. It can be prevented by preheating the base metal, increase the cross section area of the

(2) Cold crackings:- These cracks are formed near the weld area are due to excessive cooling rates & absorbed hydrogen. since these appear long time after the welding operation, when the material is cold. They constitute a great danger in the low alloy & high carbon steel.

⑤

Lamellar Tearing:-

It is generally seen in at the edge of the heat affected zone - It appears as a long and continuous usual separation line b/n the base metal and the heat affected zone. This is caused by the presence of elongated inclusions such as Mn, Fe & S in base metal.

**Edge joint:-** This joint is obtained by joining two parallel plates

② It is economical for plates having thickness  $< 6$  mm.

③ **T-joint:-**

It is obtained by joining two plates whose surfaces are approximately at right angles to each other

② These joints are suitable up to 3mm thickness.

③ These are widely used to build thin walled structures.

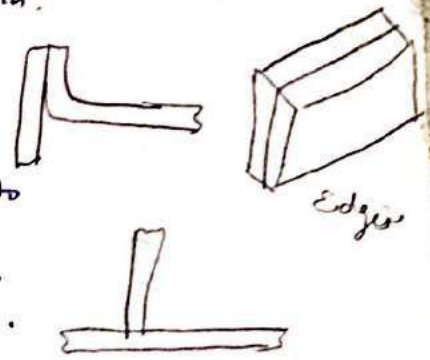

**Terminology:-**

① **Backing:-** It is the material support provided at the root side of a weld to aid in the control of penetration

② **Base Metal:-** The metal to be joined or cut.

③ **Bead (or) weld bead:-** Bead is the metal added during a single pass of welding. The bead appears as a separate material from the base metal.

④ **Craters:-** In arc welding, a crater is the depression in the weld metal pool at the point where the arc strikes the base-metal plate.

⑤ **Deposition Rate:-** The rate at which the weld metal is deposited per unit time is the deposition rate and is expressed as kg/h.

⑥ **fillet weld:-** The metal fused into the corner of a joint made of two pieces placed at approx 90° to each other.

⑦ **Penetration:-** It is the depth up to which the weld metal combines with the base metal, as measured from the top surface of the joint.

⑧ **Puddle:-** The portion of the weld joint that melted by the heat of welder.

⑨ **Root:-** It is the point at which the two pieces to be joined by welding is nearest.

⑩ **Lock weld:-** A small weld, generally used to temporarily hold the two pieces together during actual welding.

⑪ **Toe of weld:-** It is the junction b/w the weld face & base metal.

⑫ **Torch:-** In gas welding, the torch mixes the fuel and  $O_2$  and controls its delivery to set the desired flame.

⑬ **weld face:-** It is exposed surface of the weld.

⑭ **weld metal:-** The metal that is solidified in the joint is called weld metal.

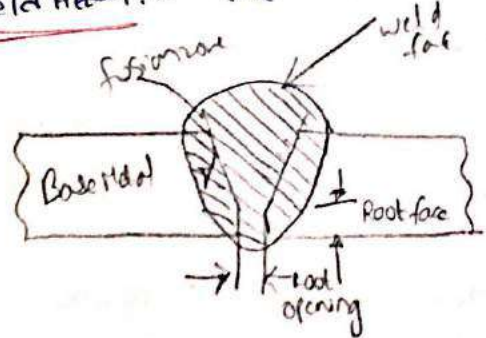

① Butt weld

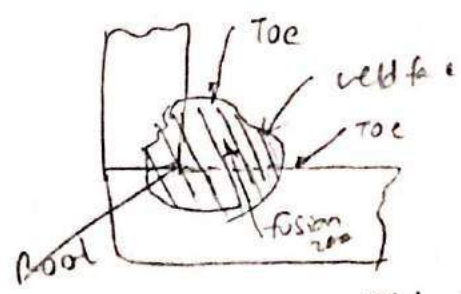

② Fillet weld 1

The oxygen is normally stored in strong cylinders at a pressure ranging from 13.8 MPa to 18.2 MPa.

Acetylene is normally made available in the following two forms: (1) Acetylene storage cylinder. (2) Acetylene generator.

Free acetylene is highly explosive, if stored at a pressure more than 200 kPa where it becomes very unstable and is likely to explode. Hence, acetylene needs to be carefully stored in a strong cylinder filled with 80 to 85% porous material such as Calcium silicate and then filled with acetylene which can absorb up to 420 times its volume of acetylene at a pressure of 1.75 MPa.

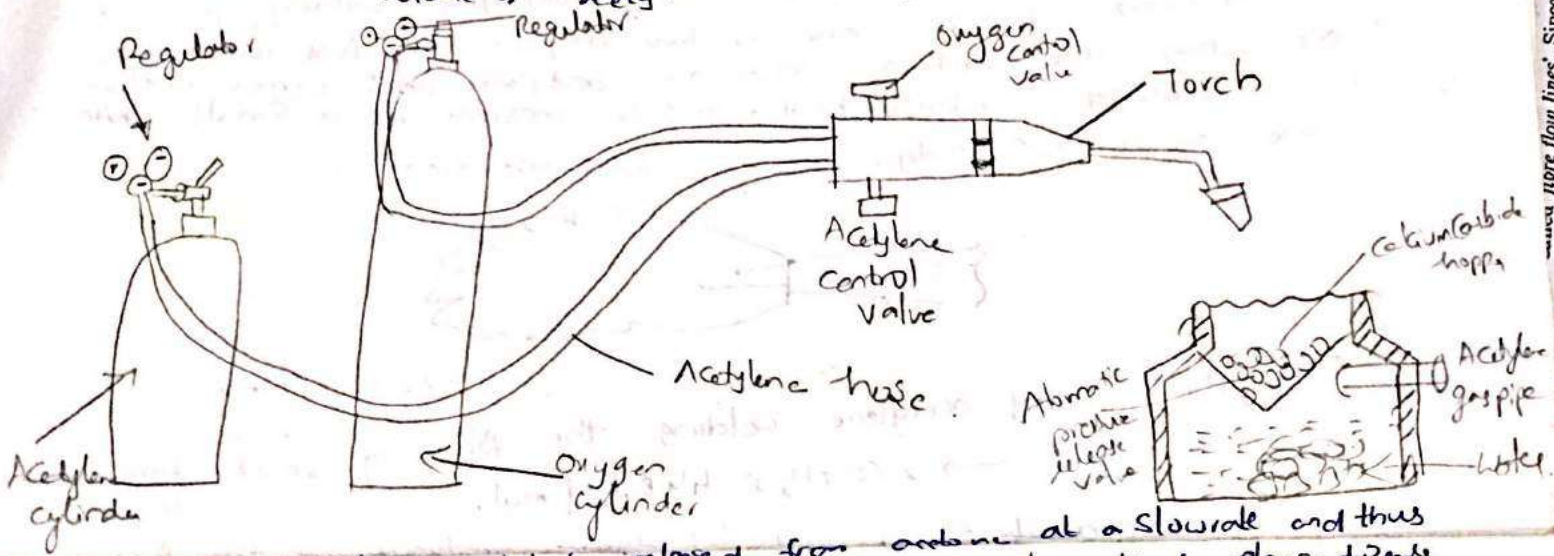

Acetylene would be released from acetylene at a slow rate and thus would not form any pockets of high pressure acetylene. The rate of release depends upon on the temp of gas. Hence, the rate of consumption of acetylene should be under the rate of release, which is normally about  $\frac{1}{7}$ th of the capacity of the cylinder per hour. However, if acetylene is drawn at a rapid rate, acetone may also come out along with the acetylene.

It is possible to have an acetylene generator in the place of an acetylene cylinder. Acetylene is normally produced by a reaction between Calcium Carbide & water which is shown.

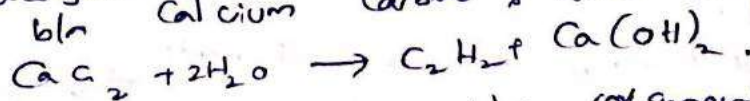

A schematic way of acetylene generator is shown in fig. It consists of a cylinder, which is partially filled by water. The calcium carbide is stored in a hopper near the top of the generator. A pressure regulated valve controls the flow of calcium carbide into water, depends upon the pressure of the acetylene in the generator. The acetylene is taken out through a pipe as shown in fig.

The oxygen & acetylene from the two cylinders are brought through separate hose pipe to the welding torch as shown in fig.

Oxy-fuel

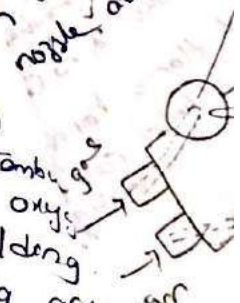

### Gas welding:-

The gas welding is also called as oxy-fuel gas welding (OFW) derives the heat from the combustion of a fuel gas such as acetylene in combination with oxygen. The oxy-acetylene welding process can be used for welding almost all metals and alloys. The advantage of using acetylene instead of other fuels, with oxygen is that it produces a comparatively higher temp. flame.

In all the oxy-fuel gas welding processes, the combustion takes place in two stages. The first reaction takes place when the fuel gas such as acetylene and oxygen mixture burn releasing intense heat. This is present as a small white core as shown in fig.

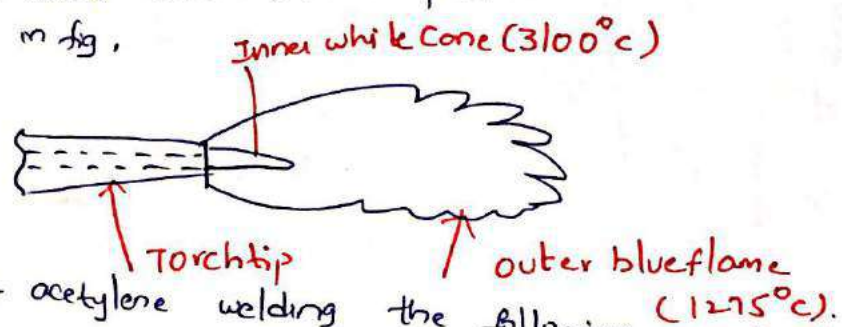

For the oxy-acetylene welding, the following reaction takes place in this zone

$$2C_2H_2 + O_2 \rightarrow 2CO + H_2 + 4H \quad 8 \text{ kJ/mol.}$$

The Carbon Monoxide (CO) and hydrogen produced in the first stage further combine with the atmospheric and give rise to the outer bluish flame with the following reaction.

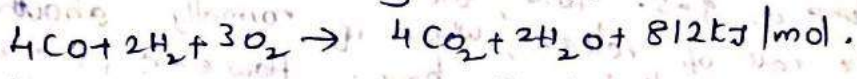

Though higher amount of heat is produced in the second stage since it is distributed over a large area, the temp achieved is small (1200-2000°C) in the flame. The inner white core temp is of the order of 3100°C, which is used for directly melting the steel joint.

### Oxy-Acetylene welding Equipment:-

The principle of oxy-acetylene welding is the ignition of oxygen and acetylene gases, mixed in a blow pipe fitted with a nozzle of suitable diameter. This flame is applied to the edges of the joint and to a wire filler of the appropriate metal, which is there by melted and run into the joint.

A typical oxy-acetylene welding outfit is shown in fig. It contains the supply units for oxygen and acetylene with associated regulators and the torch, which mixes the two gases before they are ignited.

In the torch, the two gases are mixed & then flowed out through the nozzle at the torch tip.

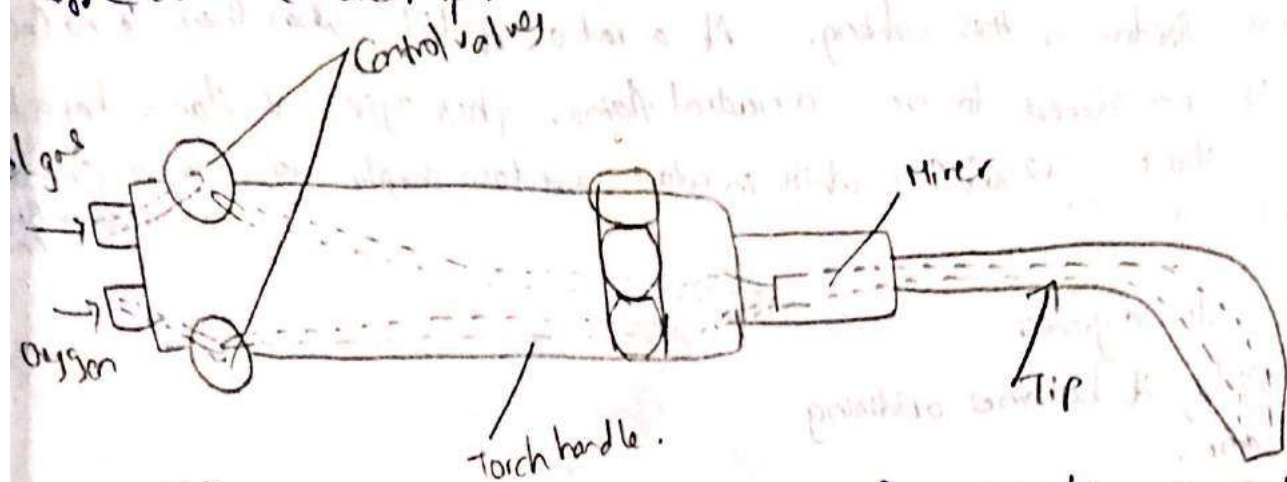

Methods of welding:- ① leftward or forward welding ② rightward or backward.

① Leftward welding:-

After suitable preparation of the joint the weld is commenced at the right-hand side of the joint and blow pipe is given a steady forward movement with a slight side ways motion, zigzagging along the weld towards the left as shown in fig. The blow pipe is kept at an angle of  $60^\circ$  to  $70^\circ$  to the surface of the work so that the flame plays ahead of it, and the filler rod held at angle of  $30^\circ$  to  $40^\circ$  is held just ahead of the flame.

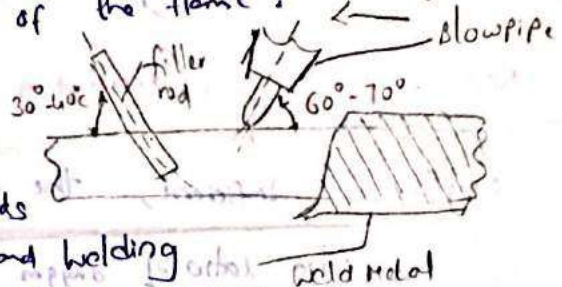

② Rightward or backward welding:-

In this welding technique the flame is directed towards the completed part of the joint and welding proceeds from left to right as shown in fig. The filler rod is given a circular movement as it is fed into the flame.

This is used for thicker materials, steel.



Types of flames:-

3 Basic types of oxyacetylene flames used in this welding are:-

- ① Neutral flame
- ② Oxidizing flame
- ③ Carburizing (or) reducing flame

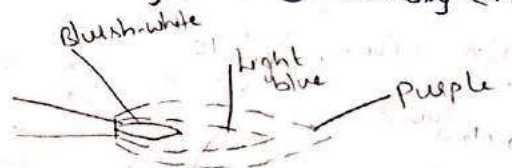



The proportions of acetylene and oxygen in the gas mixture is an important factor in this welding. At a ratio of 1:1, when there is about 3250°C, it is considered to be a neutral flame. This type of flame has a sharply defined central core of tungsten electrode.

**(B) Oxidising flame:**

With a greater oxygen supply, it becomes oxidising flame.

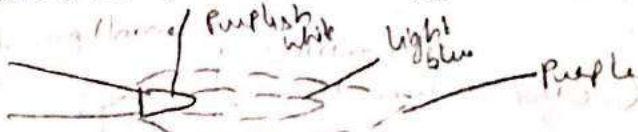

The ratio of oxygen to acetylene varies from about 1.2 to 1.5. It is used to weld copper, brass, bronze etc.

This flame is harmful, especially for steel, because it oxidizes the steel. Only in the welding of copper & copper alloy based alloys is an oxidising flame desirable, because in those cases a thin protective layer of slag forms over the molten metal.

**(C) Reducing flame (or) Carburizing flame:**

If the ratio of oxygen is deficient, the flame becomes a reducing flame.

→ The ratio of oxygen to acetylene is 0.9 to 1.

Has a Temp of 3150°C.

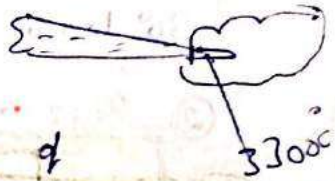

The temp of the reducing flame is lower, so it is suitable for applications requiring low heat such as brassy solders & flame-hardening.

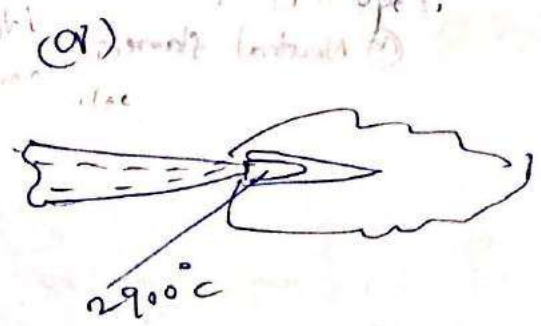
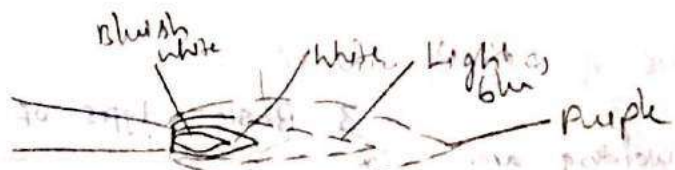

# Tungsten Inert Gas Welding (TIG):

Gas Tungsten Arc welding. This welding process is also called as Gas Tungsten Arc welding. It uses non-consumable electrode. The electrode may also contain 1 to 2% thorium oxide mixed along with the core tungsten or tungsten with 0.15 to 0.40% zirconium oxide.

It consists of a welding torch at the centre of which is the tungsten electrode. The inert gas is supplied to the welding zone through the annular path surrounding the tungsten electrode to effectively displace the atmosphere around the weld pool.

In this process the heat necessary to melt the metal is provided by a very intense electric arc which is struck between a virtually non-consumable tungsten electrode and metal work piece. The electrode does not melt and become a part of the weld. In joints where filler metal is required, a welding rod is fed into the weld zone & melted with base metal in the same as that of oxyacetylene welding. The major inert gases used are argon & helium.

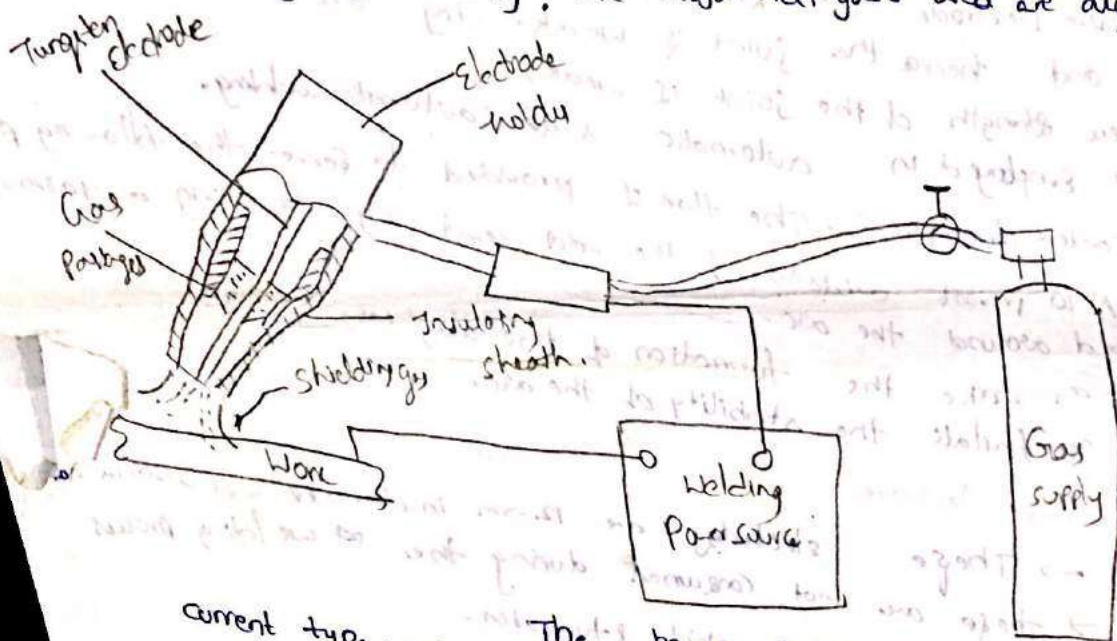

The power sources used are always the constant current type. Both direct current (dc) and alternating current (ac) power can be supplied. Both can be used for TIG welding. When dc is used, the electrode can be negative (DCEN) or positive (DCEP). When DCEN more heat is generated near the work piece and consequently the electrode does not get heated to a great extent. But when DCEP is used, a large amount of heat is liberated at the electrode itself thereby limiting the maximum current that can be carried by an electrode.

### Advantages:-

- ① TIG welds are stronger, more ductile and more corrosion resistant than welds made with ordinary shielded arc welds.
- ② Since no granular flux is required, it is possible to use a wider variety of joint designs.

3. There is little weld spatter that damage the surface of the metal as in traditional shielded arc welding.

Applications:-

- ① The TIG process lends itself ably to the fusion welding of aluminium and its alloys, stainless steel, Magnesium alloys, nickel, low alloy steels.
- ② TIG welding can also be used for combining of dissimilar metals.

Electrodes:-

The electrodes are of two types:-

① Consumable Electrode

- (i) Bare Electrode
- (ii) Flux coated Electrode

(i) Consumable Electrode:-

(i) Bare Electrode:- → These electrodes do not prevent oxidation of the weld and hence the joint is weak. They are used for minor repairs where strength of the joint is weak. → employed in automatic & semi-automatic welding.

(ii) Flux coated Electrode:-

The flux is provided to serve the following purposes of the weld bead by creating a gaseous shield.

metal  
Inert  
Gas  
of metals  
welded  
in the  
is

# Metal Inert Gas Welding (or) Gas-Metal-Arc welding (GMAW) :- (MIG)

MIG (or) GMAW, utilizes a consumable electrode as though Gas Tungsten Arc welding (or) TIG can be used to weld all types of metals, it is more suitable for thin sheets. When thicker sheets are to be welded, the filler metal requirement makes GMAW difficult to use.

The typical set up for GMAW (or) MIG process is shown in fig. The consumable electrode is in the form of a wire reel, which is fed at a constant rate, through the feed rollers. The welding torch is connected to the gas supply cylinder, which provides the necessary inert gas. The electrode and the work piece are connected to the welding power supply. The power supplies are always of the constant-voltage type only. The current from the welding machine is changed by the rate of feeding of the electrode wire.

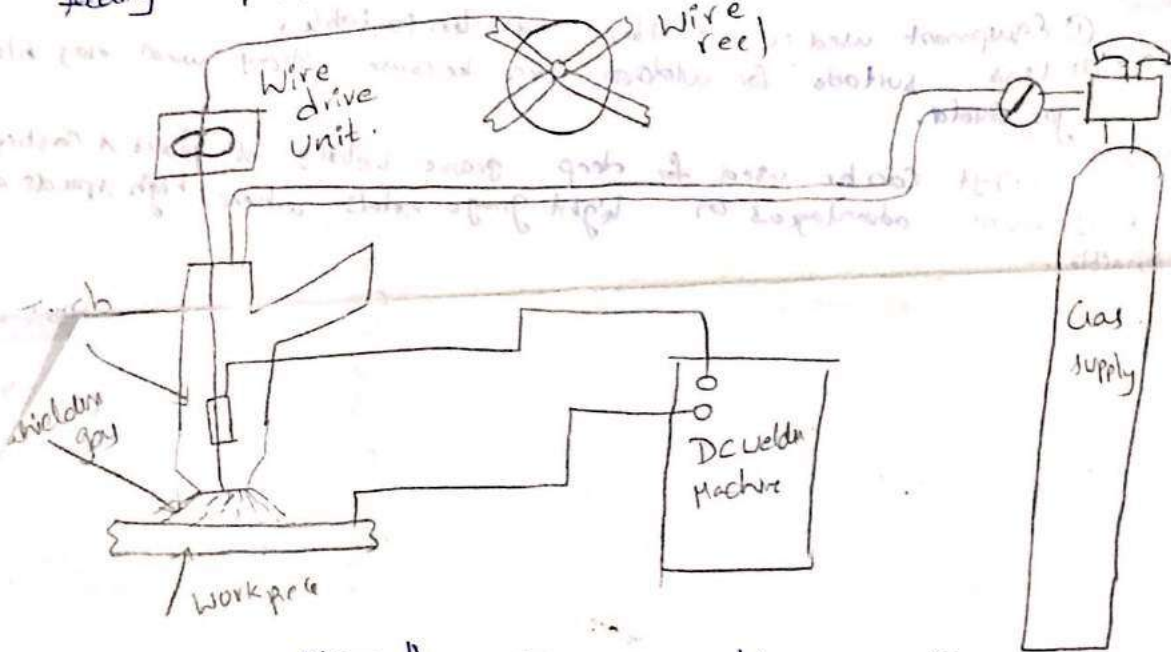

Normally, dc arc-welding machines are used for GMAW with electrode positive (DCEP). The DCEP increases the metal deposition rate and also provides for a stable arc and smooth electrode metal transfer.

- ① **Metal Transfer:-** In GMAW process, the filler metal is transferred from electrode to the joint. Depending upon the current & voltage used for given electrode, the metal transfer is done in diff ways. They are
- ① short circuit (or) dip transfer
  - ② globular transfer
  - ③ spray transfer

The short circuit metal transfer occurs with relatively low current settings of the order 75 to 175 A for an electrode dia of 0.9 mm. Fig shows the manner in which the sequence of metal transfer takes place takes in S.C

- (a) Arc ignity
- (b) wire end melt
- (c) Short circuit
- (d) Pinching of electrode end

Adv:-

- ① It provides higher ~~per~~ deposition rate
- ② It is faster than shielded metal arc welding due to continuous feeding of filler metal
- ③ welds produced are of better quality
- ④ There is no slag formation.
- ⑤ Deeper penetration is possible
- ⑥ More suitable for welds of thin sheets.

Limitations:-

- ① Equipment used is costlier and less portable
- ② Less suitable for outdoor work because strong wind may blow away the gas shield.

Applications:-

It can be used for deep groove welding of plates & castings but it is more advantageous on light gauge metals, where high speeds are

## Submerged Arc welding (SAW):-

After working jobs. It is possible to use larger welding electrodes (12mm) as well as very high currents (4000A) so that very high metal-deposition rates of the order of 20kg/h or more can be achieved with this process. Also, very high welding speeds (5m/min) are possible in SAW. Some SAW machines are able to weld plates of thickness as high as 75mm. It is more economical for larger welds.

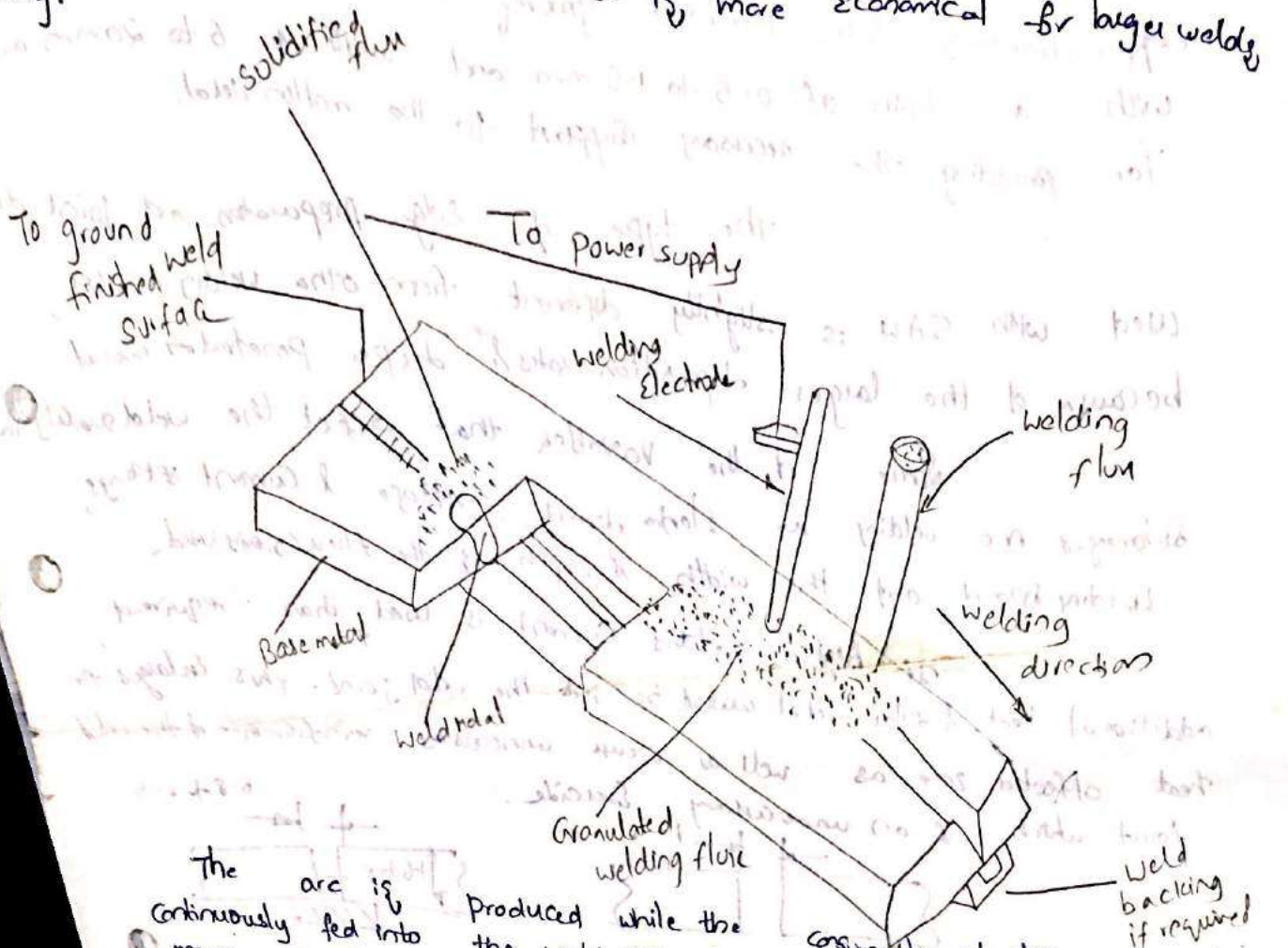

The arc is produced while the consumable electrode wire which is continuously fed into the weld zone is completely covered by means of a large amount of granulated flux, which is delivered ahead of the welding electrode by means of a welding flux-feed tube. The arc occurring between the electrode and the workpiece is completely submerged under the flux and not visible from outside. A part of the flux melts and forms the slag, which covers the weld metal as shown.

The power source used with SAW can be either A.C. or D.C. Since the arc is completely submerged in the flux there is no spatter of the molten metal. Since this process uses loose granulated flux to cover the joint, it is not possible to carry out in any position other than the flat or down hand position. The electrode wires normally used are of size 1.6, 2, 2.5, 3.15, 4, 5, 6.3 & 8 mm. The wires should be smooth with no surface imperfections or contaminants.

Being a large volume process, the SAW process produces molten weld metal ~~per~~ which takes sometime for solidification. The normally used. The backing plates can be with or without the most commonly used are copper plates, which can be cooled with running water, when necessary.

for welding plates that are less than 3mm copper-backing plates without grooves are used. for thick plates with a depth of 0.5 to 1.5 mm and width of 6 to 20 mm for providing the necessary support to the molten metal.

The type of edge preparation and joint used with SAW is slightly different from other welding processes because of the larger deposition rates & deeper penetrations involved.

Some of the variables that affect the weld quality in submerged arc welding are electrode diameter, voltage & current settings, welding speed and the width & depth of the flux covers used.

If higher welds current is used, than required additional heat & filler metal will be into the weld joint. This enlarges the heat affected zone as well as cause unnecessary reinforcement of the weld joint which is an unnecessary expense.

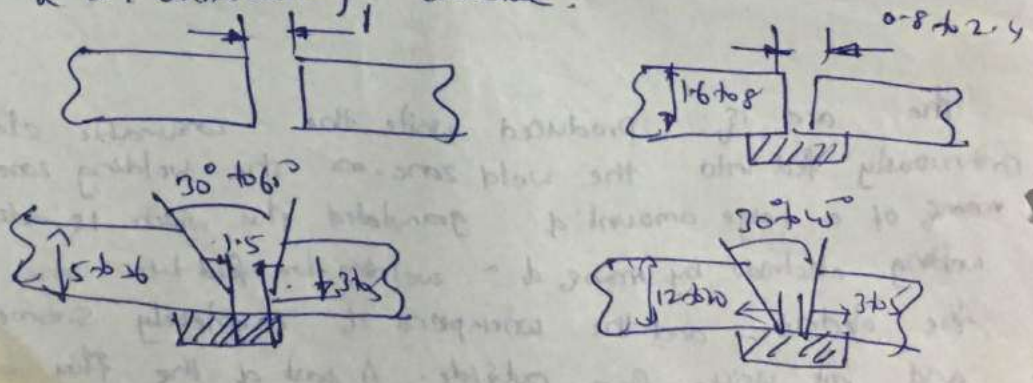

Some typical edge preparations for

Submerged Arc welding.

The welding processes are generally fusion welding process where the both heat and pressure are applied on the joint but no filler metal or flux is added.

It is the method of uniting two pieces of metal by the passage of a heavy electric current while the surfaces are pressed together.

Principles- In RW, a low voltage (1V) and very high current (15000 A) is passed through the joint for a very short time (0.25 s). This high amperage heats the joint, due to the contact resistance at the joint & melts it. The pressure on the joint is continuously maintained and the metal fuses together under this pressure. The heat generated in resistance welding can be expressed as  $H = KI^2Rt$ . where  $H$  = total heat generated in the work,  $I$  = electric current A,  $t$  = time for which the electric current is passing through the joint.

Successful operation of a resistance welding process depends upon proper control of following factors (1) welding current (2) welding pressure (3) resistance of the work piece plates.

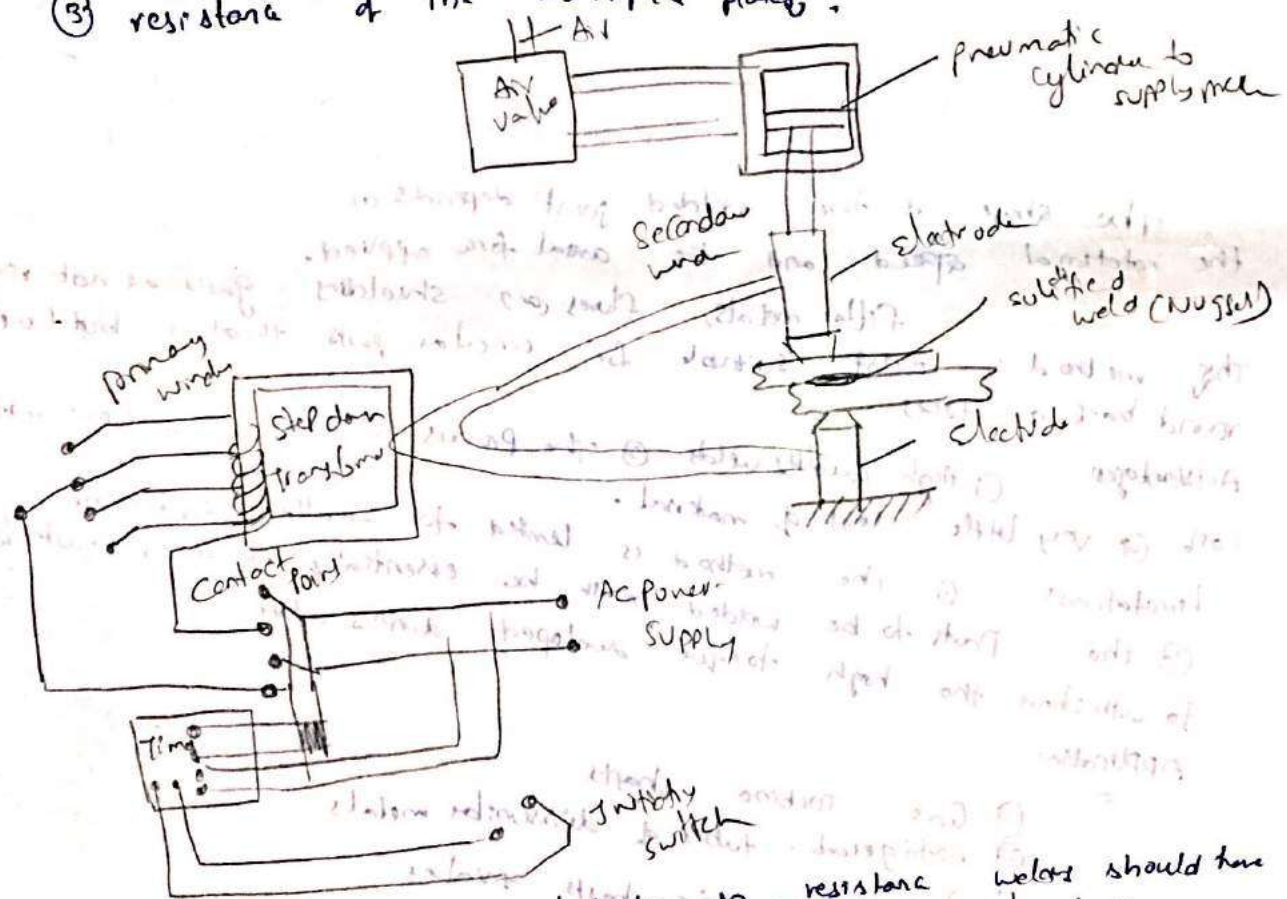

Electrodes:- The electrodes in resistance welders should have higher electrical conductivity as well as higher hardness.   
 → steel though strong, do not have conductivity required for electrodes. Hence, copper in alloyed form is generally used for making electrodes   
 → copper cadmium (0.5 to 1%) alloys have the highest electrical conductivity with moderate strength & are used for welding non-ferrous materials.



Advantages: (1) It can be used any where (2) Low set-up cost (3) Not operation (4) most suitable for welding of thick sections.

Limitations: (1) only thick sections can be welded (2) High set-up cost

Applications: (1) This is widely employed in shipping, steel (2) It can be used for welding non-ferrous parts.

PPer chrom  
Scan the above  
(1) The  
of reproducible  
used to  
Dis:- (1) c  
(2) c  
Resist  
shad

**FRICITION welding:-** In this welding process, often termed as "rub welding", the two surfaces to be welded are rotated relative to each other under light normal pressure. When the interface temp increases due to frictional rubbing and when it reaches the required welding temp sufficient normal pressure is applied & maintained until the two pieces get welded.

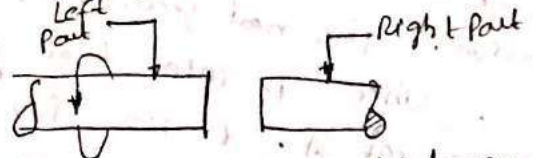

(1) Rotate left part at high speed.

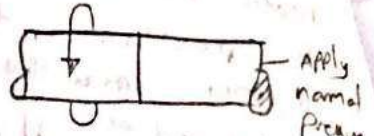

(2) Bring right part in contact & apply axial force

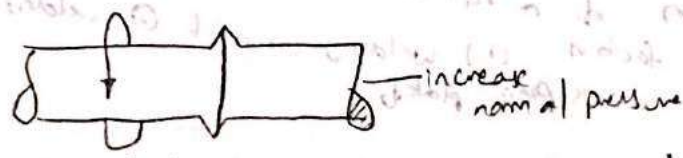

(3) Flash begins to form when axial force is increased

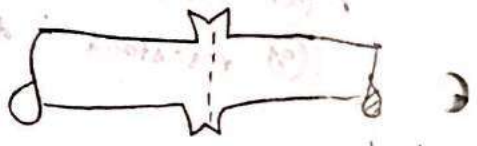

(4) Stop rotating left part when flash is formed.

The shape of the welded joint depends on the rotational speed and the axial force applied.

This method is most suitable for circular parts that is butt-welding of round bars & tubes. Filler metals, fluxes or shielding gases are not required.

Advantages: (1) High quality welds (2) The process is clean (3) Low initial capital cost (4) very little loss of material.

Limitations: (1) The method is limited to smaller components. (2) The parts to be welded must be essentially round & must be able to withstand the high torque developed during welding.

Applications:-

- (1) Gas turbine shafts
- (2) Refrigerator tubes of dissimilar metals
- (3) Aero-engine drive shafts & valves
- (4) steering columns.

*[Faint, illegible handwritten text at the top of the page]*

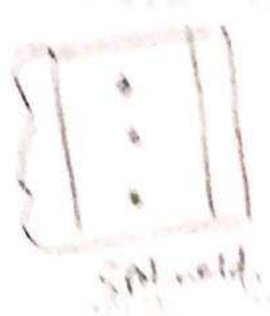
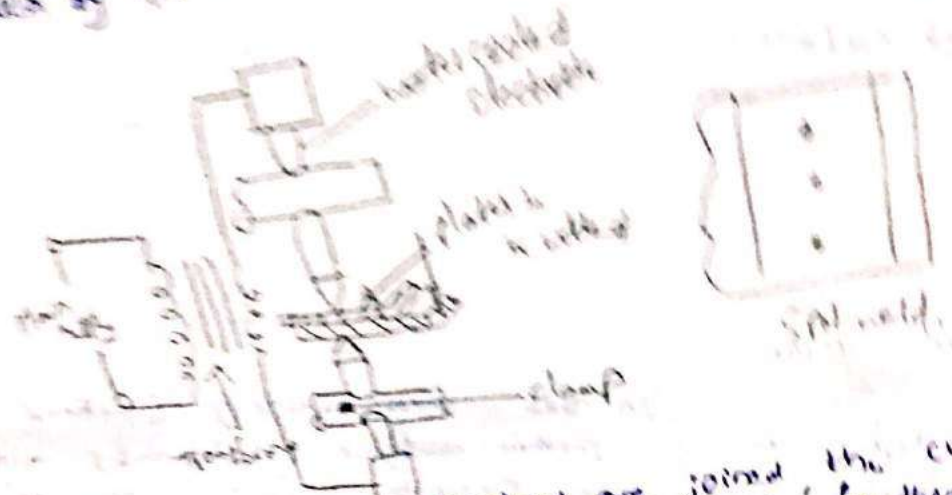

When sheets of unequal thickness are joined, the current density setting for the thinner sheets are given used. Similarly, the electrode pressure is varied, using the same settings as for two thickness. Currents usually range from 3000 A to 100,000 A. Steel, brass, copper & light alloys can be joined by this method.

**Applications -** It is widely used for fabricating sheet metal products. Examples are: 1) electrical range from auto parts handles to stainless steel. 2) copper in roped spot welds of automobile bodies uses multiple electrodes.

- Advantages:**
- ① High production rate
  - ② Economical process
  - ③ High skillless
  - ④ Most suitable for welded sheet metals.
  - ⑤ Non-generated
  - ⑥ Absence of warping or distortion of parts.
- Limitations:**
- ① Suitable for thickness only
  - ② High equipment cost.

Resistance seam welding - Seam welding is analogous to spot welding. The difference is the electrodes are in the form of rollers and the work direction perpendicular to roller axis. The current is interrupted times a minute to give a series of overlapping spot welds. Usually done under water to keep the breaking of the weld rollers work to a minimum, and thus to give lower roller maintenance and distortion of the work.

Welding current ranges from 2000A to 5000A. While the force applied to the rollers as high as 5KN to 6KN. Typical welder speed is 1.5m/min for thick steel.

Applications - It is employed on many types of pressure tanks for oil switches, transformers, refrigerators, evaporators, condensers, paint cans, varnish containers.

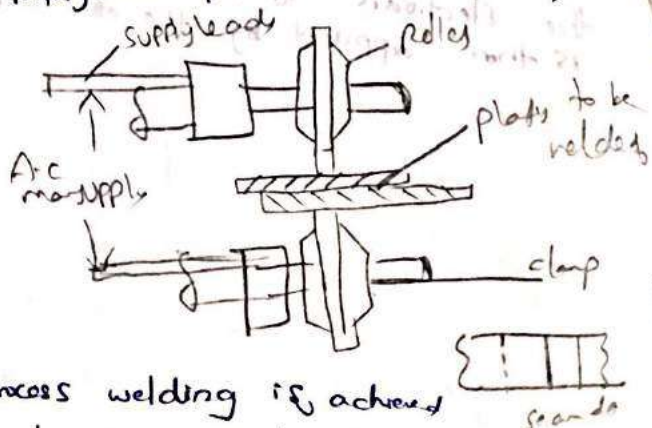

### Explosive WELDING:-

In this process welding is achieved through very high contact of pressure developed by detonating a thin layer of explosive placed over one of the pieces to be joined. The detonation imparts high kinetic energy to the piece which on striking the other piece causes plastic deformation & squeezes the contaminated surface layers out of interface resulting in a high quality welded joint.

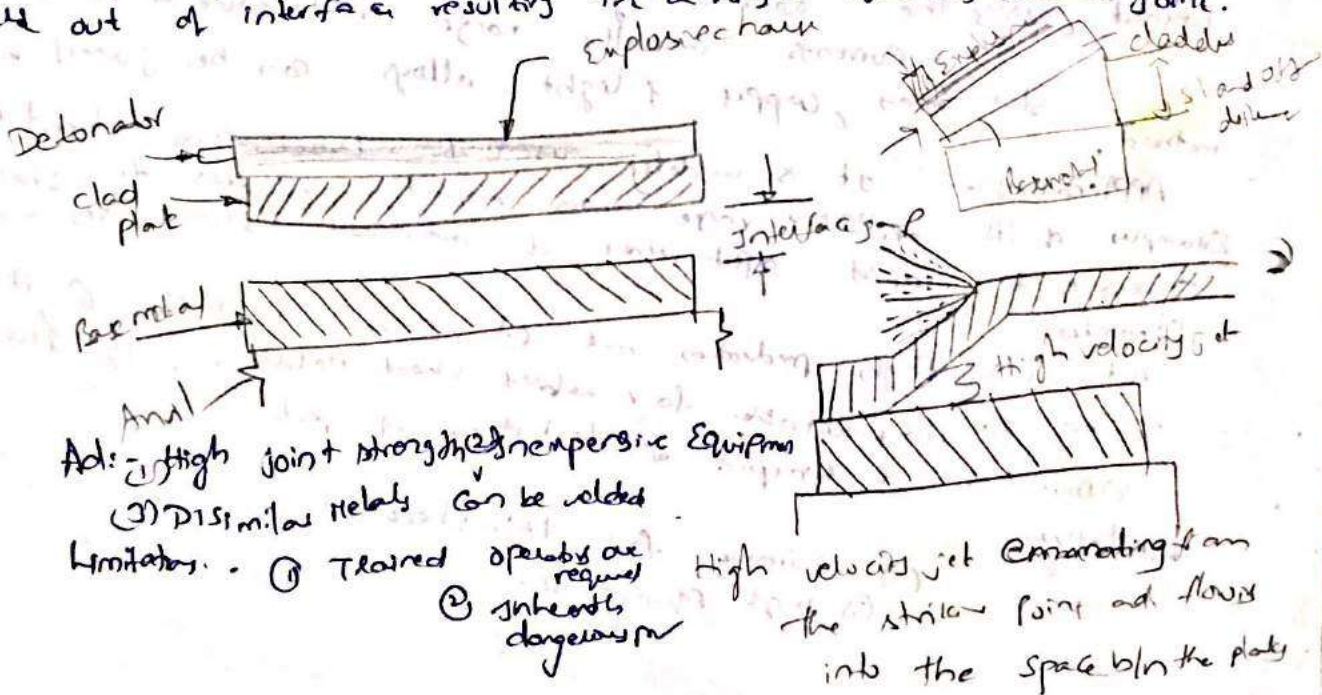

Adv: High joint strength, non-penetrative equipment.  
 (3) Dissimilar metals can be welded.  
 Limitations: (1) Trained operators are required. (2) Inherently dangerous.

## plasma Arc Welding:-

plasma is often considered the fourth state of matter. plasma is the state of matter when the part of the gas is ionised making it a conductor of electric current. It is the state of the matter present in between the electrodes in an arc. It also uses a non-consumable tungsten electrode and a shielding gas such as argon, like TIG process. The main diff is in the construction of the torch.

In plasma arc welding the plasma arc is tightly constrained as shown in fig. A small amount of the pure argon gas flow is allowed through the inner orifice surrounding the tungsten electrode to form the plasma gas. Because of the squeezing action of the constraining nozzle, the arc in PAW is concentrated & straight. This increases the heat contained per unit volume of the arc plasma. The plasma gas is forced through the torch surrounding the anode. The main function of the plasma gas is shielding the body of the torch from the extreme heat of the cathode.

To initiate the arc in PAW, a low current pilot arc is obtained b/n the electrode and the constricting nozzle which ionises the plasma gas flowing through the nozzle.

The plasma gas flowing through this constriction reaches a very high temp & provides a low resistance path to initiate the welding arc b/n the electrode and the work pce. This is termed a transferred arc. The equipment necessary for PAW includes a conventional DC power supply.

The two main types of torches for welding and cutting with plasma arc are -

- ① Transferred arc
- ② Non-transferred arc

① Transferred arc: plasma jet torch is similar to TIG torch, except that it has the water-cooled nozzle b/n the electrode & work. This nozzle constricts the arc, increasing its pressure.

The plasma, caused by the collision of gas molecules with high-energy electron, is then put through the nozzle onto the work. This type of plasma jet is completely independent of the work pce, with the power supply forming the main current path b/n electrode & work pce.

② The Non-transferred arc torch extends the arc from the electrode, or the cathode to the end of the nozzle. The nozzle acts as the anode. This type of plasma jet is completely independent of the work pce.

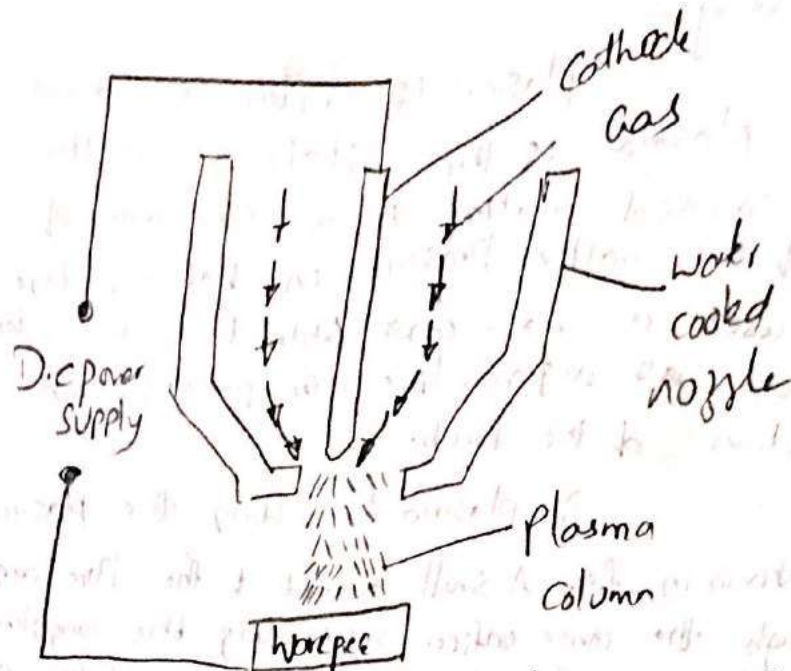

The disadvantages are however that the welding equipment is expensive and also the nozzle surrounding the electrode needs a frequent replacement.

### THERMIT WELDING:-

It is the method of uniting iron or steel parts by surrounding the joint with the steel at a sufficient high temp to fuse the adjacent surfaces of the parts together.

(1) Here a wax pattern of desired size & shape is prepared around the joint a region where the weld is to be affected.

(2) The wax pattern is then surrounded by sheet iron box and space b/w the box & pattern is filled and rammed with sand.

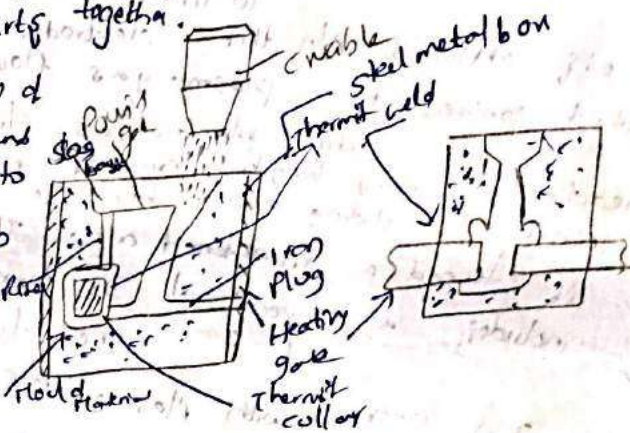

(3) After cutting, pouring & heating gates

and rises a flame is directed into the heating oven due to which the wax pattern melts and draining out the heating is continued to raise the temp of parts to be welded.

(4) The thermite mixture (finely divided aluminium iron oxide) is packed in the crucible of conical shape formed when from a sheet iron casting (lined with heat resisting current) is ignited with magnesium (nearly 2000°C) molten iron and a slag of Aluminium

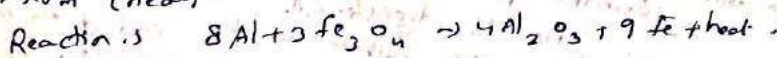

(5) The molten iron is then run into the mold which fuses with the parts to be welded & forms a thermite collar at the joint. The weld is thus obtained one metallurgically very sound & strong.

# Soldering and Brazing

Soldering is a method of joining similar or dissimilar metals means of a filler metal whose liquidus temp is below 450°C. The fusible metal is called 'solder'.

It is a quick method of making joints in light articles made from steel, copper and brass and for wire joints such as occur in electrical work. Though soldering obtains a good joint between the two plates, the strength of the joint is limited by the strength of the filler metal used. The soldered joints are not suitable for high-temp service because of the low melting temp of the filler metals used. The joint design used for soldering is similar to that of brazing. Since the filler metals enters the soldered joint by capillary action.

A soldered joint is weaker compared to that of brazed joint. As a result, other means of mechanical fastening is used in addition to soldering to provide the necessary joint strength. The soldering joints also need to be cleaned to provide chemically clean surfaces to obtain a proper bond. Solvent cleaning, acid pickling and even mechanical cleaning are applied before soldering.

To remove the oxides from the joint surfaces and to prevent the filler metal from oxidising, fluxes are generally used in soldering. Rosin and rosin plus alcohol based fluxes are most active type and are specially used for electrical soldering work.

The organic fluxes such as zinc chloride & ammonium chloride are quick acting and produce efficient joints. Because of their corrosive nature, the joint should be thoroughly cleaned of the entire flux residue from the joint. These are to be used for only non-electrical soldering work.

The filler metals used are normally called as solders which are essentially alloys of lead & tin. The eutectic alloy (62% tin + 38% lead) has lowest at 183°C.

- The various soldering methods are:
- ① Soldering iron methods
  - ② Dip soldering
  - ③ Wave soldering
  - ④ Torch method
  - ⑤ Production Method.

① Soldering iron is a copper rod with a thin tip, which can be used for flattening the soldering material. It is also used to heat the solder and the parts to be joined.

- Soldering irons are of 2 types
- ① Those heated by heat of either solid or gaseous fuel
  - ② Those heated electrically.

An ordinary soldering iron consists of a copper point or 'bit' usually of square or rectangular cross section usually of mild steel and a wooden handle. The point is of a size chosen to suit the class of work, its purpose is to absorb heat while in the fire and to give out this heat when applied to

to join job, thus heating the two parts & melting the solder.

When applying the iron it must be held in position for a sufficiently long time to ensure that the work is heated properly, it is then drawn slowly over the surface so that it will melt the solder.

② In dip soldering a large amount of solder is melted in a tank which is closed. The parts that are to be soldered are first cleaned properly and dipped in a flux bath as per requirement. These are then dipped into the molten solder pool and lifted with the soldering complete.

Wave soldering is a variant of this method, where the part to be soldered e.g., an electronic printed circuit Board, PCB is not dipped into the solder tank, but a wave is generated in the tank so that the solder comes up and makes the necessary joints. This is now a continuous process with the PCB's being continuously moving on top of the solder tank and the waves being continuously generated.

Advantages:-

- ① Low cost
- ② simplicity and cheapness of the equipment
- ③ Good & effective in fabrication as compared to other processes like riveting, spotwelding etc.

Applications:-

- ① Connections in wireless set, radio, T.V sets etc.
- ② Wiring joints in electrical connectors, battery & other terminals
- ③ Radiator brass tubes for motor car.
- ④ Copper tubing carrying liquid fuel gas or air used in engine.

Precautions

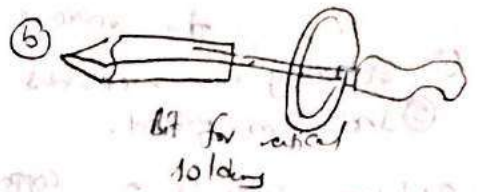
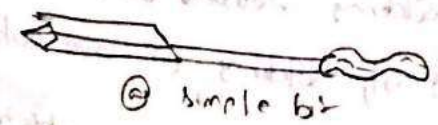

Various types of joints

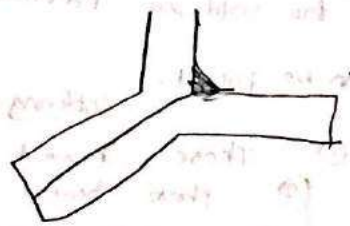
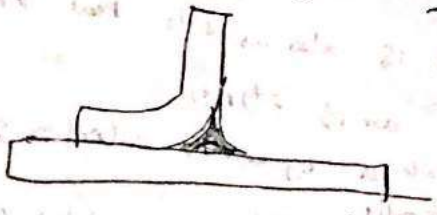

soluble  
is heated to  
will heat  
in a long  
formed  
on dip

**Brazing** is coalescence of a joint with the help of a filler metal whose liquidus temp is above  $450^{\circ}\text{C}$  and is below the solidus temp of the base metal. The filler metal is drawn into the joint by means of a capillary action. Because of the low temp used, there is less distortion in brazed joints. Also in many cases, the original heat treatment of the plates being joined is not affected by the brazing heat. The joint can be quickly finished with out much skill. Because of simplicity of process it is often an economical joining method with reasonable joint strength.

Brazed joint is generally not useful for high temp brazed low melting temp of the filler metal. The colour of the filler metal in the brazed joint also may not match with base metal.

The filler metal reaches the joint by capillary action. It is essential that the joint is designed properly. Another important factor to be considered is the temp at which the filler metal is entering the joint. While designing a brazed joint care is to be taken to see that the differences in the coeff of thermal expansion of two pieces to be joined are properly considered.

In brazing, joints need to be extremely clean. Any grease or oil present in the joint prevents the flow of filler metal. Oxides & salts present are removed by acid pickling. The fluxes are added to the brazed joint to remove any of the oxides present or prevent the formation of the oxides so that the base metal & filler metal remain pure during the joining.

The fluxes generally used are chlorides & fluorides. The fluxes used for ferrous materials are mixtures of borax & boric acid in a paste form. (75% borax & 25% boric acid). Alkaline bifluorides are used for brazing of stainless steel & copper alloys. A special flux containing sodium cyanide is used in brazing tungsten to copper.

Depending on the type of base metals brazed, a no. of filler metals are available.

In Dip Brazing a molten salt bath is used to supply heat to the base metal or shape in fig. A brazing joint is prepared & dipped into the bath for quick melting of brazing alloy. When the assembly is taken out of the bath, the joint cools and joint strength is obtained.

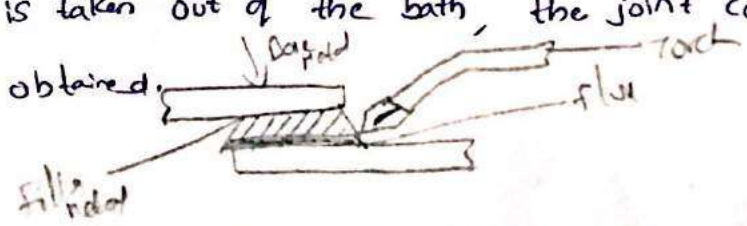

... the elastic  
... because of the  
... necessary defor.  
... mechanical force  
... application of large amount of  
... by applying a small force  
... the displacement of  
... slip and twinning  
... the metal appears to  
... be seen

(19) Shot Preparing



In induction brazing, heat is obtained from high frequency induced in the work by means of the electrical coils.

In furnace brazing, a furnace with a controlled atmosphere, which is either neutral or reducing is used.

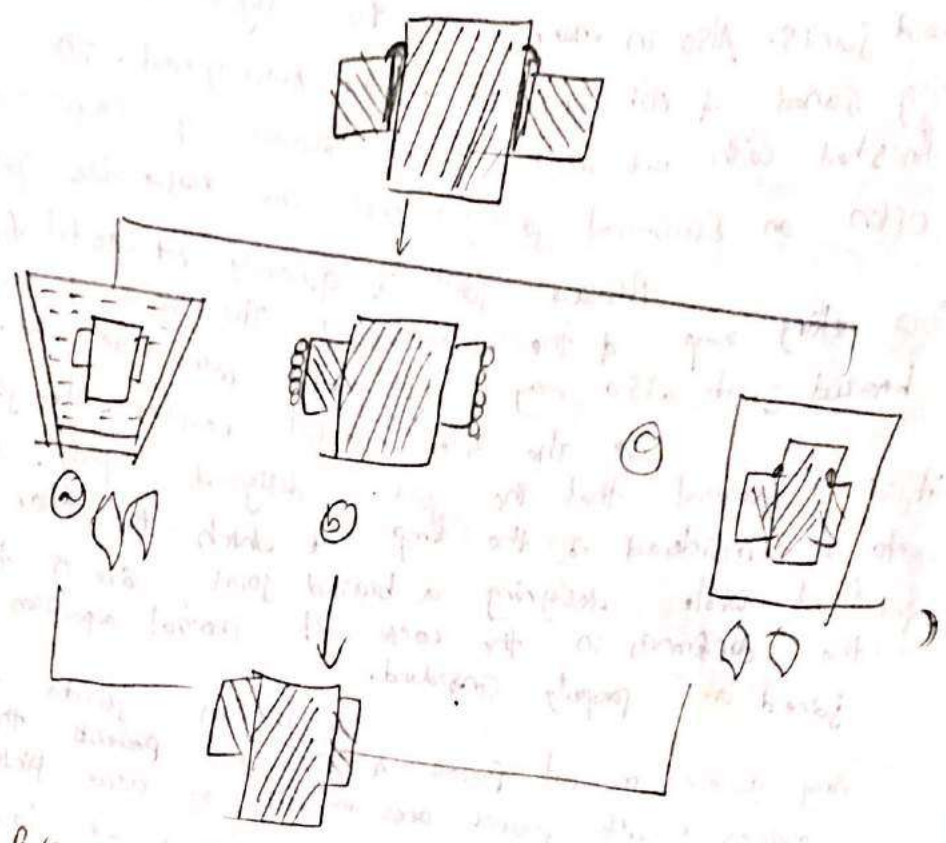

(a) Dip Brazing      (b) Induction brazing      (c) furnace brazing

# Destructive and Non-Destructive Testing of welds:-

The common methods of testing welded joints (Quantitative) destructively are:-

- ① Tension Test
- ② Bending Test
- ③ Hardness Test
- ④ Impact Test. (Workshop)
- ⑤ Roughness Test
- ⑥ Fatigue Behaviour (Laboratory)

## Non-destructive Tests (Qualitative)

- ① Visual Examination
- ② Liquid penetrant test
- ③ ultrasonic inspection
- ④ Radiography.
- ⑤ Thermal Testing.

Essentially inspecting tests are of Non-destructive and Quantitative tests that is destructive tests.

Laser Beam Welding:-

The laser welding process is the focusing of a monochromatic light into extremely concentrated beams. It employs a carefully focussed beam of light that concentrates tremendous amount of energy on a small area to produce fusion.

When capacitor bank is triggered energy is injected into the wire laser beam that surrounds the flash tube. This wire establishes an imbalance in the material inside the flash tube. Thick xenon often is used in the material for the flash tube, producing

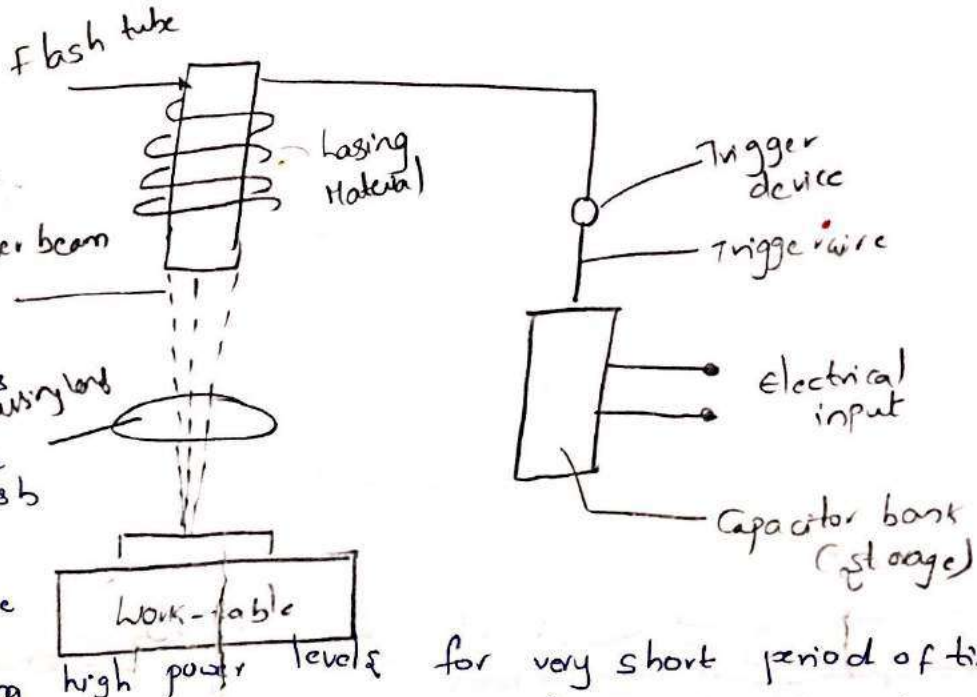

high power levels for very short period of time.

The flash tubes or lamps are designed for operation at a rate of thousands of flashes per second. By operating in this manner, the lamps become an efficient device for converting electrical energy into light energy, the process of pumping the laser. The laser is then activated. The beam is emitted through the coated end of the lasing material. It goes through a focussing device where it is pin-pointed on the work piece. Fusion takes place and the weld is accomplished.   
 CO<sub>2</sub> laser can produce deeper welds at higher rates of speed.

Advantages:-

- ① This process can be used to weld dissimilar metals.
- ② Welds can be made with a high degree of precision.
- ③ High depth to width ratio of weld.
- ④ High production rate.

Limitations:-

- ① High energy losses
- ② Highly skilled operation
- ③ High Equipment cost
- ④ Spatter required.

...ation which is permanent and beyond the elastic ... the material. Often, metals are worked by plastic deformation because of the beneficial effect that is imparted to the mechanical properties by it. The necessary deformation in the metal can be achieved by annealing. ... only on ...  
 ... are available either ... not be used in raw form (whatever it ... Besides there are some processes ... materials are ... How...  
 ... properties. In some processes the materials are ... either surface finish nor the ... necessary. However...



**SREENIVASA INSTITUTE OF TECHNOLOGY AND  
MANAGEMENT STUDIES**

**CHITTOOR, ANDHRA PRADESH- 517127**

**AN ISO 9001:2015 CERTIFIED INSTITUTION**

**(AUTONOMOUS and ACCREDITED BY NAAC & NBA, PERMANENTLY AFFILIATED TO JNTU ANANTHAPURAMU)**

**DEPARTMENT OF MECHANICAL ENGINEERING**

NOTES FOR

**MANUFACTURING TECHNOLOGY**

**UNIT-III**

**ROLLING, EXTRUSION AND DRAWING PROCESSES**

## UNIT-3

### ROLLING, EXTRUSION AND DRAWING PROCESSES

The materials which are covered under the scope of material science are available either from nature or industry. However these materials cannot be used in raw form for useful purposes. They have to be shaped and formed into articles through different manufacturing processes.

Mechanical working processes are used to achieve optimum mechanical properties in the metal. Metal working reduces any internal voids or cavities present and thus makes the metal dense. The impurities in the metal also get elongated with the grains and in the process get broken and dispersed through out the metal. This decreases the harmful effect of impurities and improves mechanical strength.

When materials are subjected to external loads, they get deformed. The deformation may be elastic, plastic or fracture depending upon the load and the properties of the material. Elastic deformation is said to have occurred when the material returns to its original shape on removal of load and when it does not return to its original shape on removal of load but retains its new configuration, the material is said to have deformed plastically. Further deformation causes the material to fracture resulting in separation of a part of material from the body of material.

COLD AND HOT WORKING:-

cold working:- When plastic deformation of metal is carried out at temp below the recrystallisation temp, the processes performed on metals are termed as cold working.

The various cold working processes are:

- (1) Drawing (2) Bending (3) squeezing (4) shearing (5) shot peening.

Advantages of cold working:-

- ① Handling of material is easy.
- ② Good surface finish and better dimensional accuracy.
- ③ Energy saving since heating is not required.
- ④ Strength, fatigue and wear properties are improved.
- ⑤ Minimum contamination because of low working temp.
- ⑥ Economical for smaller sizes.
- ⑦ Highly suitable for mass production and automation, because of low working temp.
- ⑧ Thin gauge sheets can be produced.

Disad:-

- ① Deformation energy required is high, so rugged and more powerful equipment is required, thus equipment cost is high.
- ② Severe stresses are set up, this requires stress relieving which increases the cost.
- ③ cold working for large deformation requires several stages with interstage annealing, which increases production cost.
- ④ During cold working residual stresses are set up. As their presence is undesirable a suitable heat treatment is generally necessary to neutralise these stresses and restore the metal to its original structure.

## Differences between cold working and hot working

### Cold working

- (1) Cold working is done at a temp below the value required for recrystallization.
- (2) Hardening is not eliminated as working is done at a temp below recrystallization.
- (3) Cold working decreases the value of elongation, reduction of area and impact values.
- (4) Crystallization does not take place, so refinement of crystals does not occur.
- (5) Uniformity of material is lost and properties are affected a lot.
- (6) chances of crack propagation is more.
- (7) Internal and residual stresses are produced.
- (8) Energy required for plastic deformation is more.
- (9) More stress is required for deformation.
- (10) NO oxidation of metal occurs during working and hence pickling is not required.
- (11) Embrittlement does not occur due to less diffusion and no reaction of oxygen at low temp.

### Hot working

- (1) Hot working is done at a temp above recrystallization temp, so it can be regarded as a simultaneous occurrence of deformation.
- (2) Hardening due to plastic deformation is completely eliminated by recovery and recrystallization.
- (3) Mechanical properties, like elongation, reduction of area and impact values, are improved.
- (4) Refinement of crystals occurs.
- (5) promotes uniformity of material by facilitating diffusion of alloys, constituents and breaks brittle films of hard constituents or impurity.
- (6) Cracks and voids closed below holes are sometimes welded up alternatively, serious cracks are shown up at early stage.
- (7) Internal and residual stresses are not produced.
- (8) Energy required for plastic deformation is less because at high temp, metals become soft and ductile.
- (9) Less stress is required for deformation.
- (10) Heavy oxidation occurs during working and pickling is required to remove the oxide.
- (11) Reactive metals get severely embrittled by oxygen and hence must be protected from the action of oxygen by using inert atmosphere.

Hot working:- when plastic deformation of metal is carried out at temp above the recrystallisation temp, the processes performed on metals are termed as Hot working.

The various hot working processes are:-

- ① Rolling
- ② Forging
- ③ Pipe welding
- ④ Hot spinning

Adv:-

① High production rate ② very high reduction is possible without fear of fracture. ③ Metal is made tougher because pores get closed and impurities are segregated. ④ Deformation energy required is low, hence, less powerful equipments are required. ⑤ Structure can be altered to improve the final properties. ⑥ Since hot working promotes diffusion of constituents, segregation can be reduced or eliminated.

Dis:-

- ① Handling of material is not so easy.
- ② Heat resistant tools are required which are expensive.
- ③ High temp may produce undesirable reactions.
- ④ Surface finish is poor because of scale formation.
- ⑤ Metallurgical structure may be non-uniform.



performed carried

- (i) Surface finish is good
- (13) It is easy to control the dimensions within the tolerance limit
- (14) Handling of material is easy

- (ii) Surface finish is not so good due to oxidation at high temp
- (13) It is difficult to control the dimensions because of contraction occur during cooling
- (14) Handling of material is difficult.

Difference between ingot, bloom, slab & billet:-

Ingot:- Ingots are very large casting products, greater in size and shape than blooms, billets and slabs. Ingot generally has rectangular/square cross section, but it is not necessary that it should be uniform through out its length.

Bloom:- Bloom has rectangular/square cross section. The cross section area of bloom is always greater than  $230\text{ cm}^2$ . Blooms are used as rolling material in the manufacturing process of rails, seamless pipes, etc.

Billet:- 1. Billet is also a casting product. Billets are made with the help of machine called as CCM.  
2. Billet has a square cross section area, but cross section area of billet should be same throughout its length. The cross section area of billet is always  $< 230\text{ cm}^2$ . Billets are used in the manufacturing process of steel Rebar.

Slab:- A slab has a rectangular cross section, slab has thickness lesser than bloom.  
Weight of ingot  $>$  wt of bloom  $>$  billet  $>$  slab.

## Defects in Rolling:-

The various defects are

- ① Surface defects
- ② Structural defects

① **Surface defects:** These defects may result from:

- (1) Inclusions and impurities in the material
- (2) Scale, rust, dirt.
- (3) Roll marks.

In hot rolling blooms, billets and slabs, the surface is usually pre-conditioned by various means such as by torch to remove scale.

② **Structural defects:** These defects distort or affect the integrity of the rolled product.



(i) Wavy edges

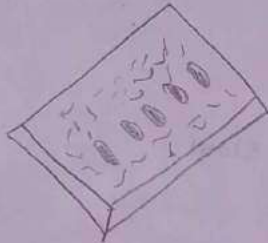

(ii) Zipper cracks

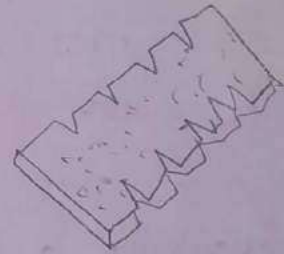

(iii) Edge cracks

(i) **Wavy edges:-** These are caused by bending of the rolls, the edges of the strip are thinner than the centre. Because the edges elongate more than the centre and are restrained from expanding freely, they buckle.

(ii) **Zipper cracks and edge cracks:-** Zipper cracks in the centre of strip and edge cracks are usually caused by low ductility & buckling.

## Rolling Stand Arrangement:-

The arrangement of rolls in a rolling mill also called rolling stand, varies depending on the application.

The names of the rolling stand arrangements are given by the number of rolls employed. The various possible configurations are presented

### ① **Two-high Roll Mills:-**

Both the rolls rotate in opposite directions to one another as shown in fig. Their direction of rotation is fixed and cannot be reversed. Thus the work can be rolled by feeding from one direction only.

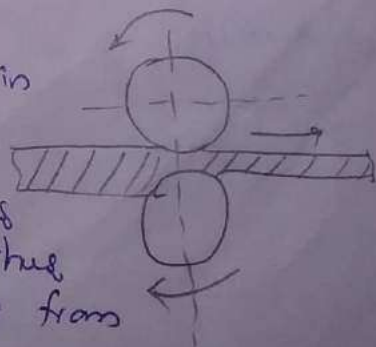

The space between the rolls can be adjusted by rotating the upper roll. The position of the lower roll is fixed.

② Three-high rolls:-

This stand arrangement is used for rolling of two continuous passes in a rolling sequence without reversing the drive. After all the metal has passed through the bottom roll set, the end of the metal is entered into the other set of rolls for the next pass.

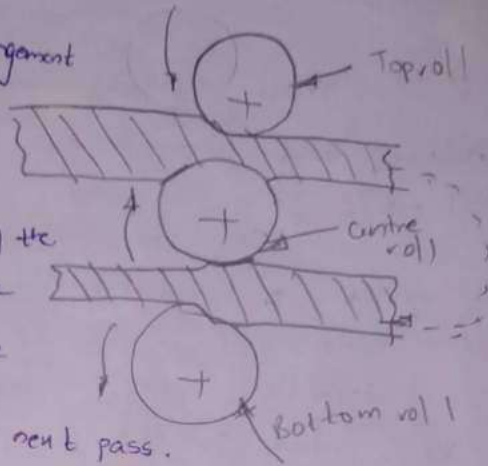

This roll <sup>arrangement</sup> is used for blooming, rolling.

④) Four-high rolls:-

This rolling stand is essentially a two-high working rolling mill, but with small-sized rolls. The other two rolls are back-up rolls for providing the necessary rigidity to the small rolls.

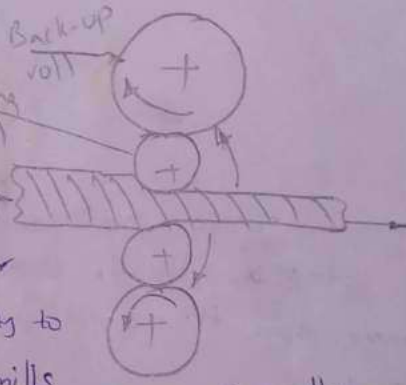

These mills are generally employed for subsequent rolling of slabs. The common products of these mills are hot or cold rolled sheets/plates.

⑤) cluster rolls:-

It consists of two working rolls of smaller diameter and four or more back-up rolls of large diameter. The number of back-up rolls may go as high as 20 or more, depending upon the amount of support needed for the working rolls during the operation.

This type of mill is generally used for cold rolling.

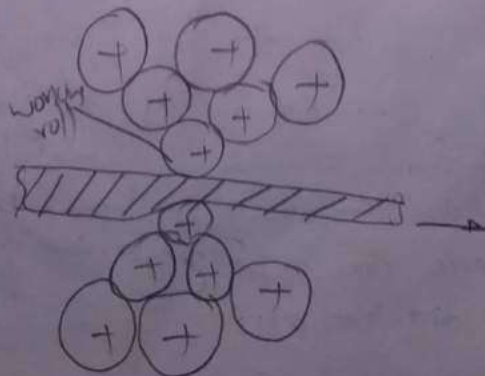

**Planetary mill:** for the rolling arrangements require large reduction, a number of free rotating wheels instead of a single small roll, are fixed to a large back-up roll in the planetary rolling mill arrangement shown in fig.

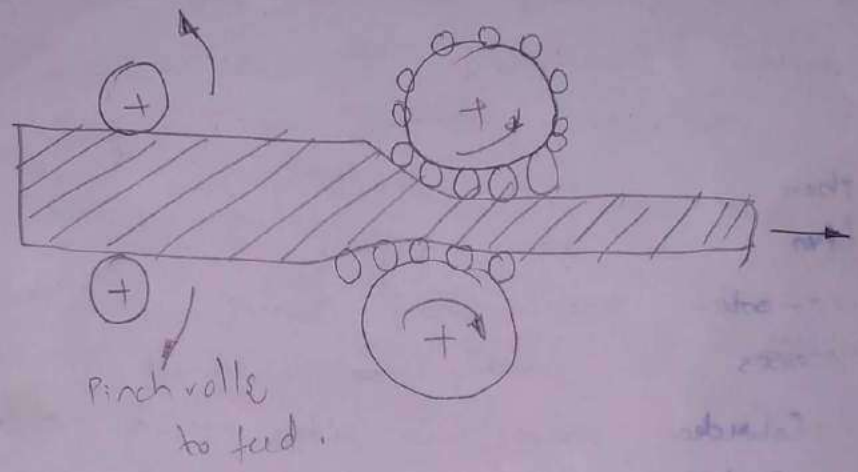

**Extrusion:**

Extrusion is the process of confining the metal in a closed cavity and then allowing it to flow from only one opening so that the metal will take the shape of the opening. The operation is identical to the squeezing of tooth paste out of the tooth paste tube.

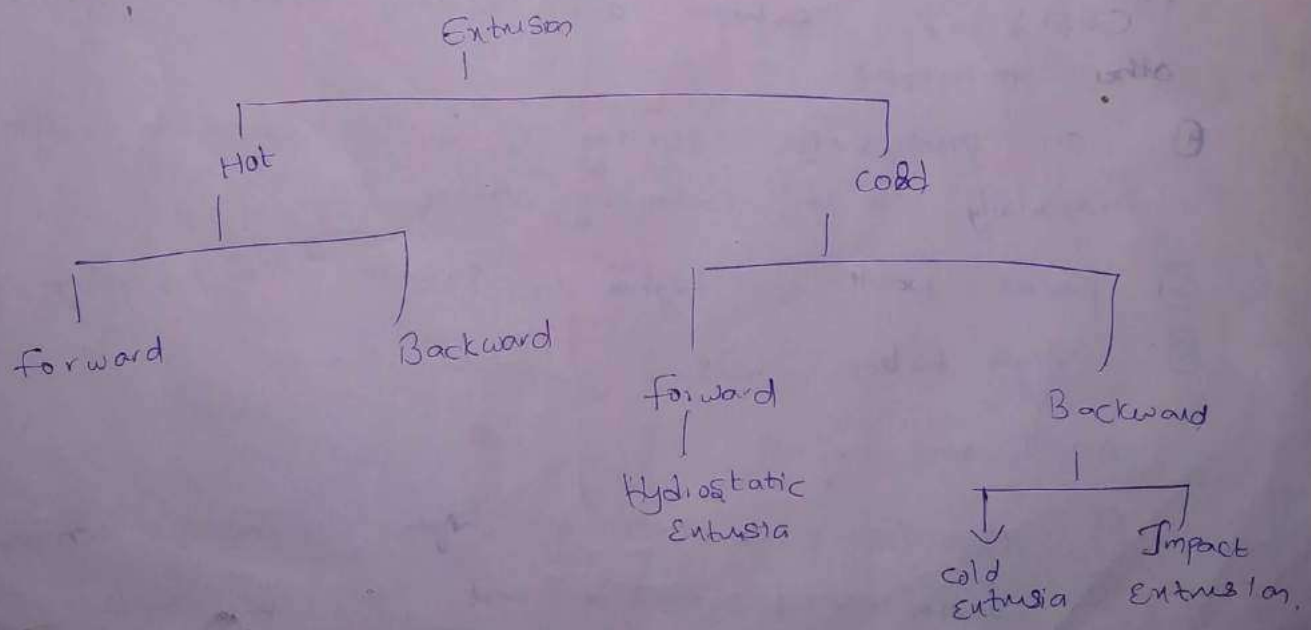

## Advantages of Extrusion

- ① Shapes can be extruded, those if produced by methods shall entail more cost comparatively.
- ② Thinner walls can be obtained by increasing the forming pressure.
- ③ The extrusion dies are less expensive comparatively.
- ④ Extrusion process allows low cost in process redesign.
- ⑤ The dimensional tolerances are very good.
- ⑥ There is more flexibility in design for adjacent thin and heavy sections as well as for difficult re-entrant angle, sharp corners, not practicable in other processes can readily be obtained by extrusion.
- ⑦ Extruded shapes can often replace weldments.
- ⑧ Extrusion is an ideal process for obtaining rods from metal having poor ductility.

## Disadvantages:-

- ① Compared to roll forming extruding speed is slow.
- ② The sizes of dies and presses that can be economically built is a limiting factor.
- ③ Costs of extrusion are generally greater as compared to other techniques.
- ④ In productivity extrusion is much inferior to rolling, particularly to its continuous varieties.
- ⑤ Process waste is higher in extrusion than in rolling.
- ⑥ High tooling costs.

## Applications:

- ① Manufacture of parts of high dimensional accuracy.
- ② Manufacture of sections and pipes of complex configuration.
- ③ Medium & small batch production.
- ④ Working of poorly plastic and non-ferrous metals and alloys.

## Backward Hot Extrusion:-

In order to completely overcome the friction, the backward hot extrusion as shown in fig is used. In this, the metal is confined fully by the cylinder. The ram which houses the die, also compresses the metal against the container, forcing it to flow backwards through the die in the hollow plunger or ram. It is termed backward because of the opposite direction of the flow of metal to that of ram movement. Thus, the billet in the container remains stationary and hence no friction. Also, the extrusion pressure is not affected by the length of the billet in the extrusion press since friction is not involved.

The surface quality achieved is generally good since there is no heat cracking due to the friction between the billet and the extrusion cylinder interface.

The disadvantage of backward extrusion is that the surface defects of the billet would end up in the final product unlike direct or forward extrusion where these are discarded in the extrusion container. Though advantageous this process is not extensively used because of the problem of handling extruding metal coming out through the moving ram.

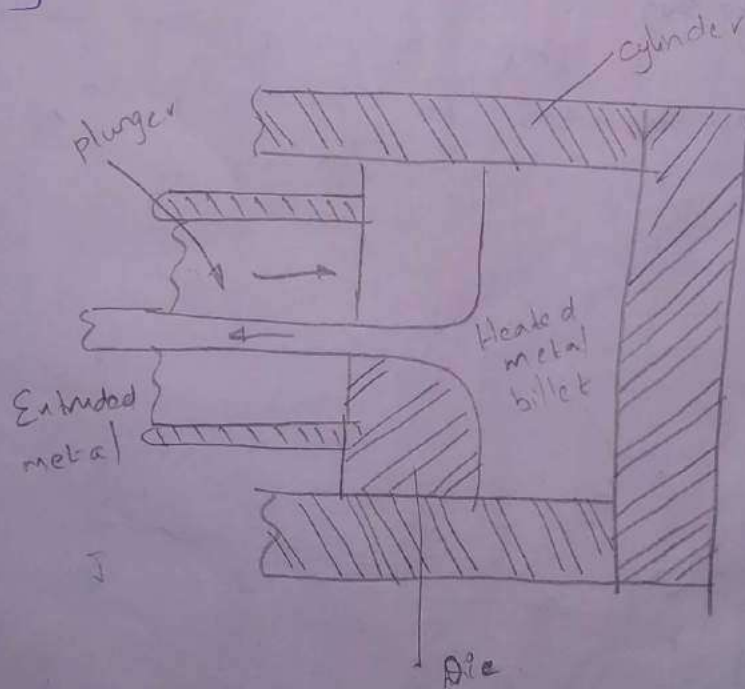

## Cold Extrusion

### (1) forward cold Extrusion:-

The forward cold extrusion is similar to that of forward hot extrusion process except for the fact that the extrusion ratios possible are lower and extrusion pressures are higher than that of hot extrusion. It is normally used for simple shapes requiring better surface finish and to improve mechanical properties. Ex of the applications are cans, shock absorber cylinder etc.

### (2) Impact Extrusion:-

The backward cold extrusion is much more commonly particularly with softer materials such as aluminium and its alloys. In backward cold extrusion called the impact extrusion, the set up consists of a die and a punch as shown in fig. The slug for making the component is kept on the die and the punch strikes the slug against the die. The metal is then extruded through the gap between the punch and die opposite to the punch movement as in fig. Because of the impact force, the side walls go straight along the punch though they are not confined. The height of the sidewalls is controlled by the amount of metal in the slug.

This process is more commonly used for making the collapsible tubes for housing pastes, powders etc.

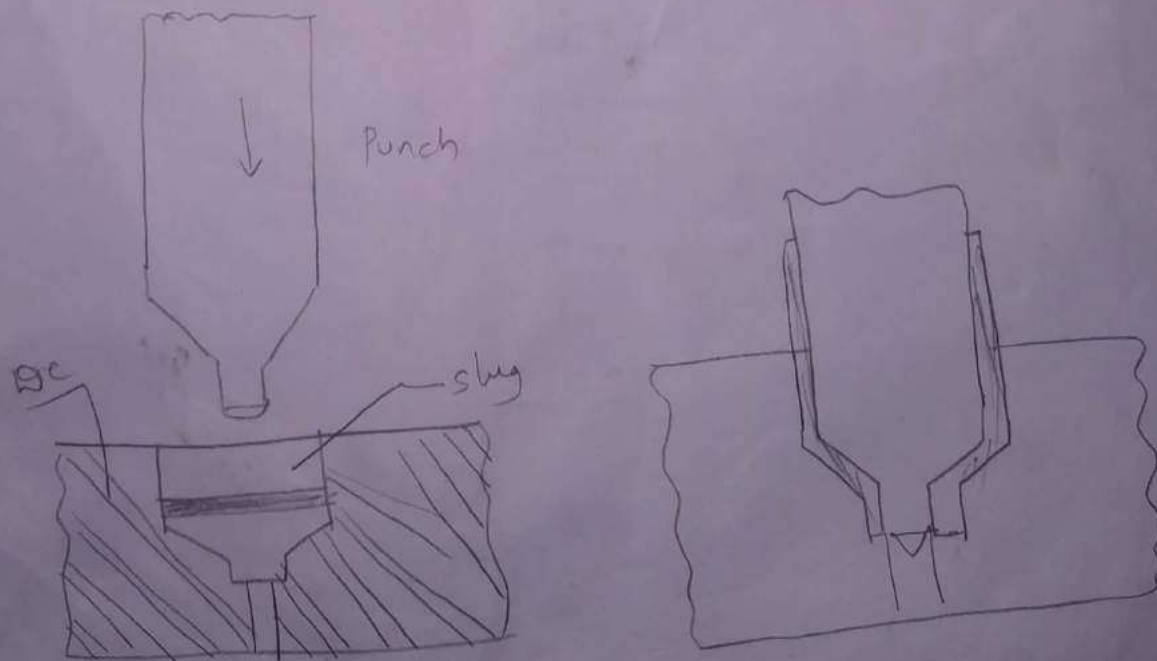

Extrusion  
of  
sheet

## Cold Extrusion Forging:-

The cold extrusion is similar to impact extrusion but with the main difference that the side walls are much thicker and their height is similar. This also contains a die and punch set as shown in fig. The punch slowly descends over the slug kept on the die, thus forging some metal between the punch and the die and the rest being extruded through the clearance between the punch and die side walls. The side walls thus generated are short and thick with any profile in the end unlike the impact extrusion. Afterwards, the component is ejected by means of the ejector pin provided in the die.

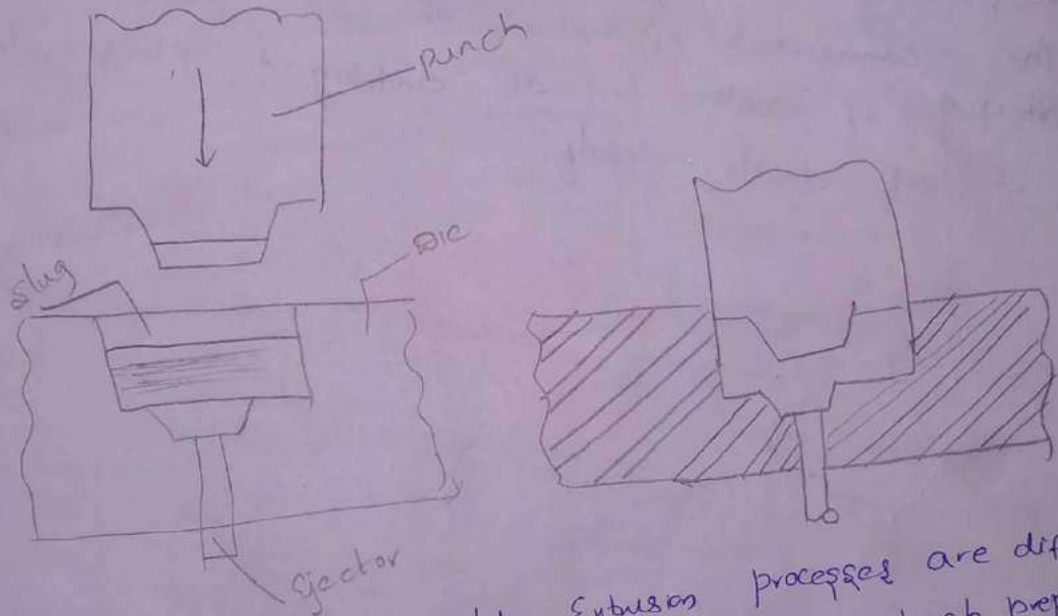

The backward cold-extrusion processes are different from other extrusion processes in that, each stroke of the punch prepares a directly usable single component which may not necessarily have a uniform cross section over its entire length. Also, these are limited to smaller sizes and for non-ferrous alloys only.



## Hydrostatic Extrusion-

Another extrusion process that is being used for special applications is the hydrostatic extrusion. In this, the billet is compressed from all sides by a liquid rather than a ram. The presence of liquid inside the container eliminates the need for any lubricant and also, the material is more uniformly compressed from all sides throughout the deformation zone. Because of this, highly brittle materials such as grey cast iron can also be extruded.

A typical hydrostatic extrusion operation is shown in fig. Some of the pressure-transmitting fluids used are castor oil with 10% alcohol, SAE 30 mineral lubricating oil, glycerine, ethyl glycol and iso pentane. The hydrostatic pressure range is from 1110 to 3150 MPa. The commercial applications of the process are limited to the extrusion of reactor-fuel rods, cladding of metals and making wires of less ductile materials.

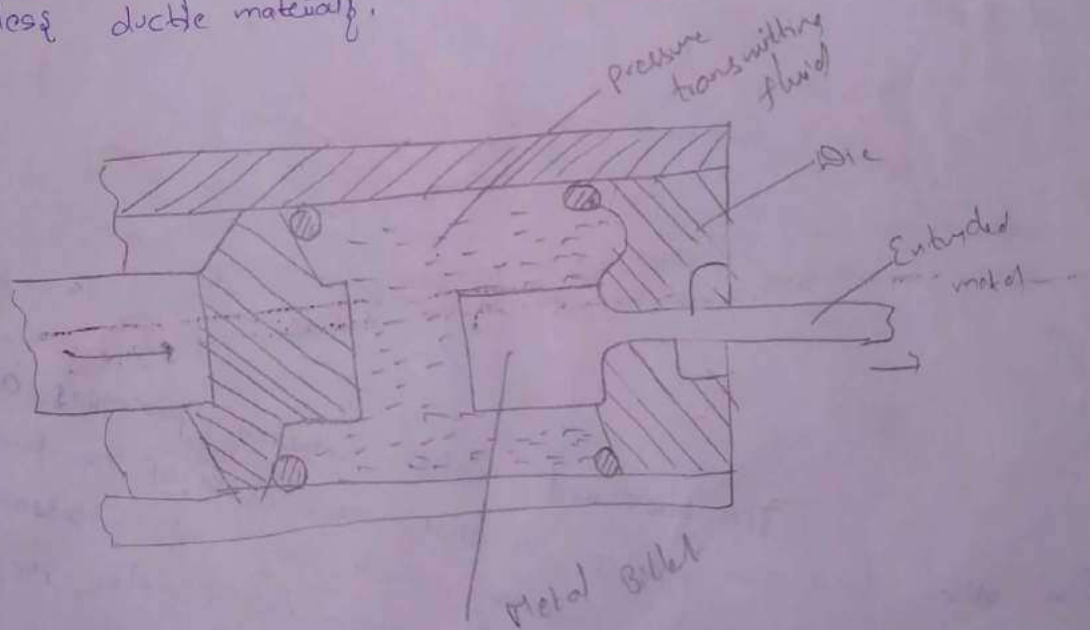

## Hot Extrusion processes:-

(1) forward (or) Direct Extrusion process:-

In this process a billet (piece of metal worked to a suitable shape) of the material to be extruded is placed in a container. At one end of the container is fixed a die while from the other end the metal is forced to flow through the die by hydraulically driven ram.

Much work must be supplied to overcome the resistance and high frictional forces b/w the billet and wall of the container and to produce the required rate of deformation. In forward extrusion, the problem of friction is prevalent because of the relative motion b/w the heated metal billet and cylinder walls. The problem of friction is particularly severe in case of steels because of their higher extrusion temp. To reduce this friction lubricants are to be used.

At low temp, a mixture of oil and graphite is generally used. Hotter glass is generally used for extruding steel.

To reduce the damage to equipment, extrusion is finished quickly and the cylinder is cooled before further extrusion.

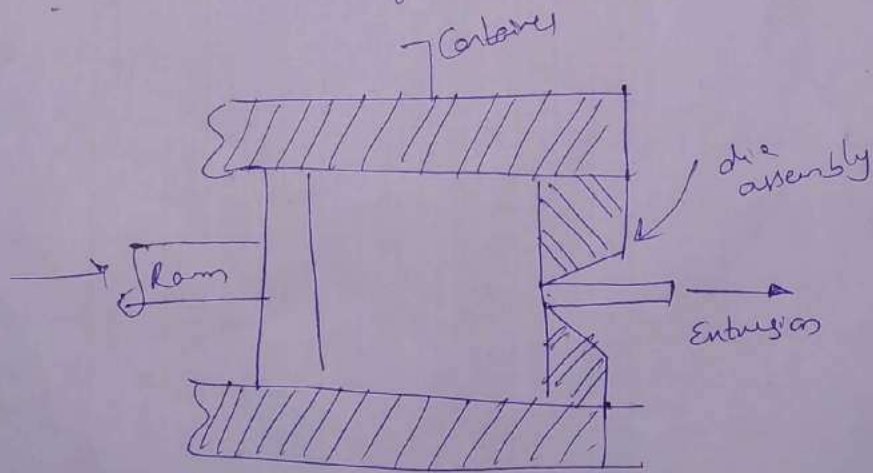

## Principle and Mechanism of Rolling:-

The process is illustrated in fig. The rolls are in contact with the passing metal piece over a sufficient distance, represented by the arc LM. The angle LOM subtended at the centre of the roll by the arc LM is called the 'angle of contact' or the 'maximum angle of bite'. It is the friction between the surfaces of the metal piece and the rolls which provides the required grip of rolls over the metal piece to draw the latter through them.

The pressure exerted over the metal by the roller is not uniform throughout, it is minimum at both the extremities L and M and maximum at a point known as no-slip point or the point of maximum pressure. At this point the surfaces of the metal and the roller move at the same speed. Before reaching this point i.e. from L to S, the metal moves slower than the roll and the frictional force acts in the direction to draw the metal move slower than the roll and the frictional force acts in the direction to draw the metal piece into the rolls. After crossing the neutral point S, i.e. from S to M, the metal moves faster than the roll surface, and the friction opposes the travel tending to hold the metal track. This results in setting up of stresses within the metal to obstruct its reduction.

Let  $t_i$ ,  $l_i$ ,  $b_i$  and  $t_f$ ,  $l_f$  and  $b_f$  be the initial and final thickness, length and breadth of the metal piece respectively.

then, Absolute draft,  $\delta t = (t_i - t_f)$  mm

Absolute elongation,  $\delta l = (l_f - l_i)$  mm

Absolute spread,  $\delta b = (b_f - b_i)$  mm.

Spread is proportional to the draft and depends upon the thickness and width of the job. Spread increases with increase in roll diameter and coeff of friction, as well as with a fall in temp of metal in course of hot rolling.

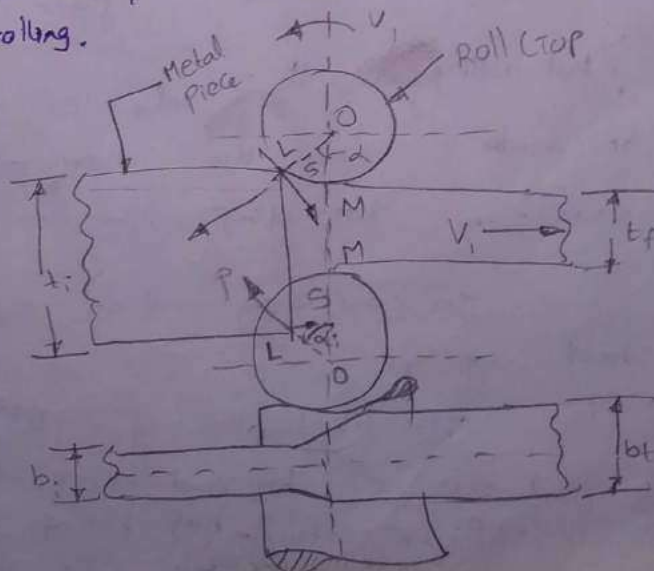

Metal rolling process

Relative draft,  $R_d = \frac{\delta t}{t_i} = \left( \frac{t_i - t_f}{t_i} \right) \times 100$ .

Elongation Coefficient,  $\epsilon = \frac{l_f}{l_i}$ .

At the moment of bite, two forces act on the metal from the side of each roll, radial or normal force  $P$  and the tangential force frictional force  $\mu P$  where  $\mu$  is coeff of friction b/w the metal and roll surfaces. The part would be dragged in if the resultant of horizontal component of the normal force  $P$  and tangential force  $\mu P$  is directed in that direction.

In the limiting case

$$P \sin \alpha = \mu P \cos \alpha$$

$$\mu = \tan \alpha \therefore \alpha = \tan^{-1} \mu$$

when  $\alpha > \tan^{-1} \mu$ , the metal would not enter the space b/w the rolls automatically that added.

The maximum permissible angle of bite depends upon the value of  $\mu$  which in depends upon:

- Materials of rolls;  $\rightarrow$  Job being rolled;  $\rightarrow$  Roughness of their surface
- Rolling temp, speed.  $\rightarrow$  <sup>Process variables in rolling process</sup> (1) Temp  $\rightarrow$  (2) Roll gap or draft.
- $\rightarrow$  (3) Coeff of friction  $\rightarrow$  (4) Dimensions of sheet.

The rolling load ( $P$ ) can be calculated as:

$$P = l \cdot b \cdot P_m$$

where  $l$  = roll-strip contact length,

$b$  = Breadth of sheet and  $P_m$  = Mean specific pressure.

Since  $l$  depends on roll diameter and angle of bite, it is approximately given as,

$$l = \sqrt{R \cdot \delta t}$$

where  $R$  = roll radius,

$$\delta t = \text{draft} = t_i - t_f$$

\* In hot rolling, the value of  $\alpha$  and hence of  $\mu$  should be greater since the maximum possible reduction is desired. usually in hot rolling, lubrication is not necessary.

In cold rolling, since the rolling loads are very high,  $\mu$  should not be much.

The usual values of bite angles are:

$2^\circ - 10^\circ$  = for cold rolling of oiled sheet and strip

$15^\circ - 20^\circ$  = for hot rolling of sheet & strip

$24^\circ - 30^\circ$  = for hot rolling of heavy billets/blanks.

## Wire Drawing:-

Wire drawing is the process of reducing diameter of metal rods by drawing them through conical openings in die blocks.

Wire drawing is fundamentally a simple process. Steel iron or non-ferrous rod is converted into wire by drawing it through a conical hole having an included angle of  $8-24^\circ$ . In continuous wire-drawing the wire passes through a succession of holes of decreasing size in dies made of steel, tungsten carbide, ruby or diamond, the reduction in cross-sectional area usually being about 30%.

The rods used for wire-drawing are first pickled in acid to remove any scale and then electrically but not welded. The end of the rod is tapered sufficiently to fit the first dies by passing it through a pointing machine, which generally takes the form of two motor-driven rollers having a number of grooves of decreasing size between which the rod is rolled. The rod may be coated with iron, hydrochloric acid or tin, applied during or after pickling. The rod is then fed into the wire drawing machine, which may be fitted with six or more dies, through which the wire is drawn by means of a number of power-driven pulleys or rotating drums.

Although the principle is similar in each case, the machines differ in design, and for practical purposes are broadly divided into wrap and slip types.

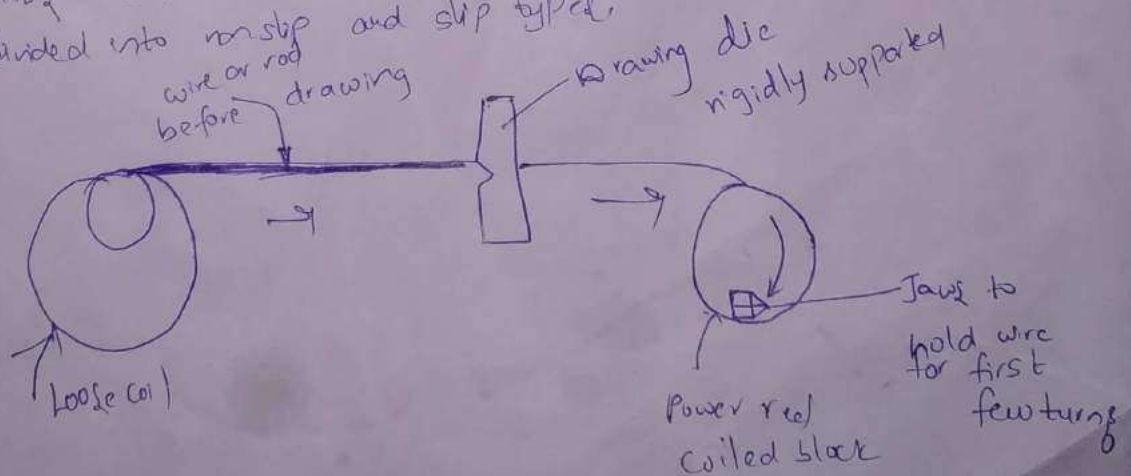

Due to the great heat generated by the friction of the wire in the dies, both the dies and drums are continuously cooled by circulating water through them.

Lubrication is often ensured by passing the rod through dry soap on its way to the die.

A different method of overcoming the cooling and lubrication problem is to employ a wet-drawing machine. Ruby or diamond dies are also employed but their use generally being confined to the drawing of fine wires of  $< 3\text{mm}$  in dia. The jewels are first trimmed and then drilled with small drills which are fed with diamond powder, oscillated by several hours.



**SREENIVASA INSTITUTE OF TECHNOLOGY AND  
MANAGEMENT STUDIES**

**CHITTOOR, ANDHRA PRADESH- 517127**

**AN ISO 9001:2015 CERTIFIED INSTITUTION**

**(AUTONOMOUS and ACCREDITED BY NAAC & NBA, PERMANENTLY AFFILIATED TO JNTU ANANTHAPURAMU)**

**DEPARTMENT OF MECHANICAL ENGINEERING**

NOTES FOR

**MANUFACTURING TECHNOLOGY**

**UNIT-IV**

**FORGING AND SHEET METAL PROCESSES**

UNIT-1

FORGING AND SHEET METAL PROCESSES

Forging is the operation where the metal is heated and then a force is applied to manipulate the metal in such a way that the required final shape is obtained.

Advantages and disadvantages of forging:

- ① Forging improves the structure of metal and hence it has mechanical properties.
- ② Forgings are easily welded.
- ③ Rapid duplication of components.
- ④ Ability of the forging to withstand unpredictable loads.
- ⑤ Metal removal in machining is minimum.
- ⑥ The forging can withstand unpredictable loads.
- ⑦ The surface of the forging is relatively smooth.
- ⑧ Superior machining qualities.
- ⑨ Minimum weight per unit strength and better resistance to shock.

Disadvantages:

- ① The initial cost of die and cost of their maintenance is high.
- ② In hot forging, due to high temp of metal, there is rapid oxidation or scaling of the surface resulting in poor surface finish.

③ Forging operation is limited to simple shapes.  
④ Forging and has limitations for parts having undercut etc.  
are usually costlier than casting.



Basic categories of forging:-

- ① open-die forging      ② Compression die-forging

① Open-die forging: This type of forging is distinguished by the fact that the metal is never completely confined and shaped by various dies.

Open-die forging, in its simplest form, generally involves placing a solid cylindrical work piece between two flat dies and reducing its height by compressing it. This process is known as upsetting. Under ideal conditions, a solid cylinder deforms as shown in fig. (a) this is known as homogeneous deformation. Fig (b) shows deformation in upsetting with friction as the die-work piece interfaces, the specimen develops a barrel shape.

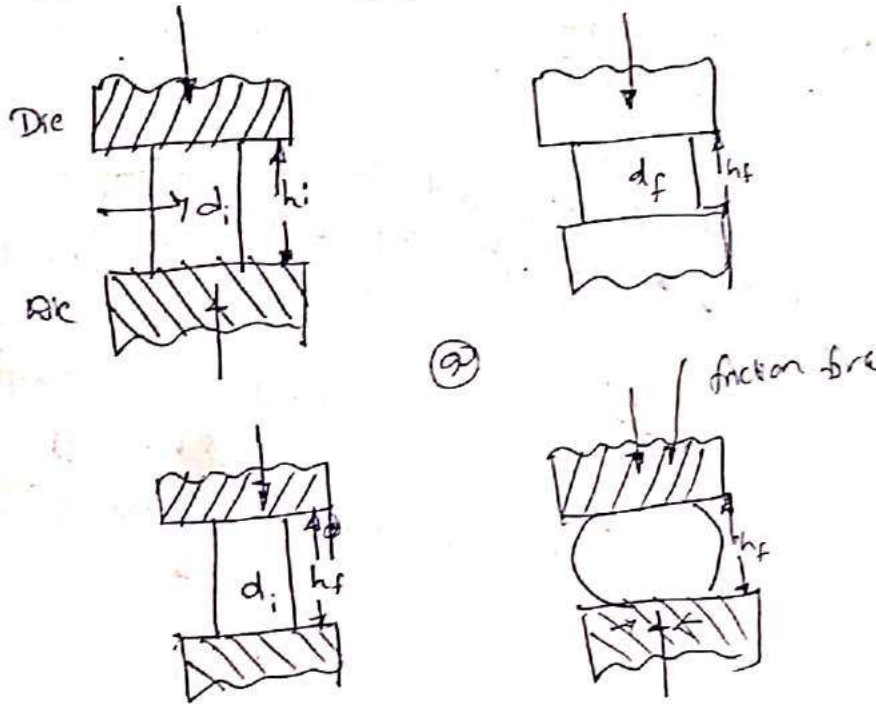

- Adv:-
- ① simple to operate
  - ② simple for low production volume
  - ③ Inexpensive tooling & equipment
  - ④ wide range of work piece size can be used.

Limit

- ① suitable for simple shapes only.
- ② Can be employed for hot run production only
- ③ Material utilisation is poor
- ④ skilled workers are required.
- ⑤ Since machining is often required, final cost of production may be higher than other forging methods.

Open die forging is a forging process in which flat (or) slight contoured die are used to compress a work piece, reducing its thickness and increasing its length. The distance travelled by die in forward direction on the workpiece between each forging step is called the BITE.

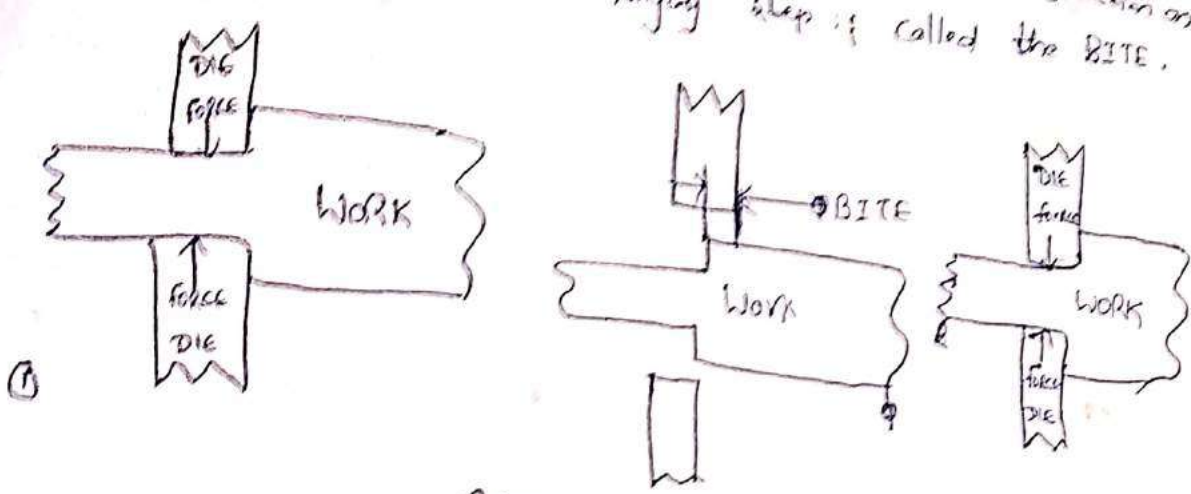

Cogging operation.

(i) FULLERING:- In fullering, open die with convex surfaces are used to deform the work piece. The result is to cause material to flow out of one area and to both sides. Fullering is mostly used as an earlier step to prepare the work piece for further forging processes.

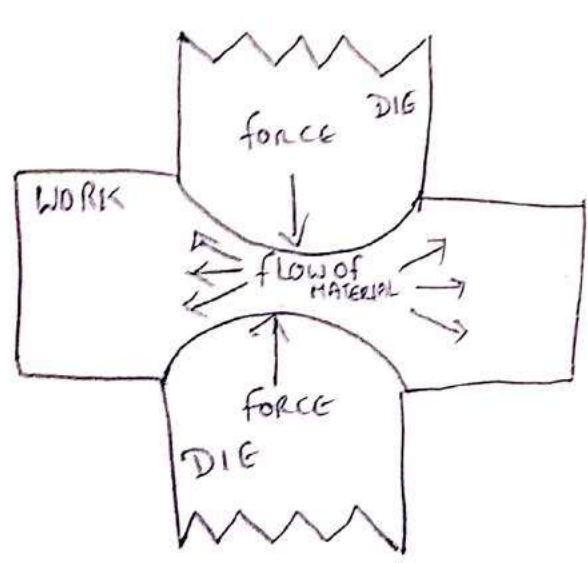

The removed portion is called a blank.

Reduced to simplest terms, a set of blanking tools consists of a bed and punch. The latter is attached to the ram of the machine and the former is clamped to the bed to the press. When the tools are set, the punch should first enter the bed without touching the sides in such a manner as to damage the cutting edge.

The clearance between the cutting edge is regulated to suit the thickness of the metal to be cut with the tools in position, the punch should be adjusted to enter the bed for the minimum distance necessary to give complete shear. If it is permitted to enter too far, the punch is subjected to unnecessary wear. With tools in position and properly set, the tail end of the downward stroke of the ram forces the punch to carry the material it covers into the bed. The surrounding metal cannot enter, hence is sheared off. In order to obtain a blank free from burr, that is with a clean sheared edge, particular attention should be given to the clearance and condition of the cutting edges.

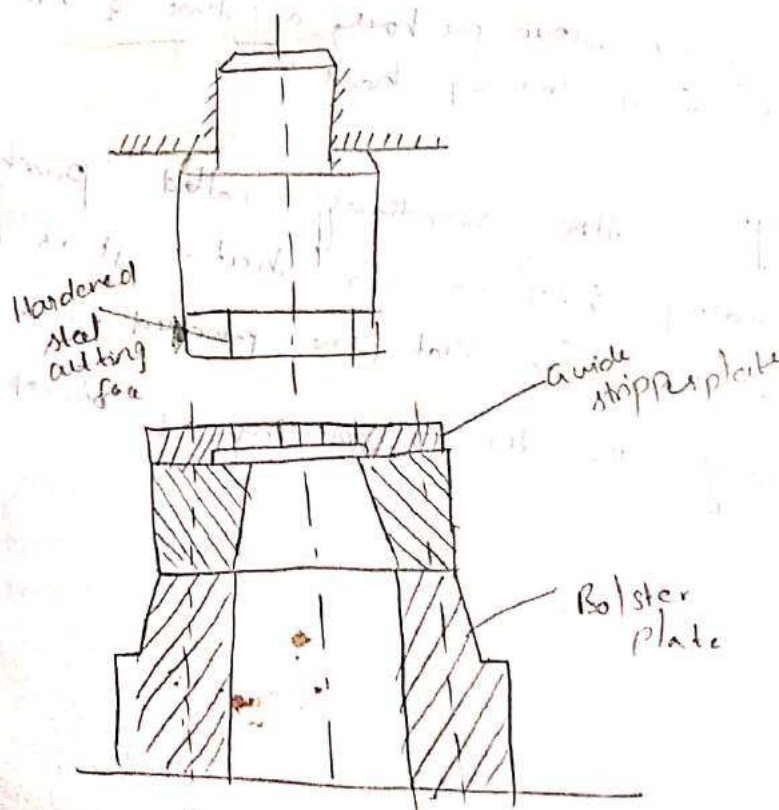

Fig. shows a typical lay out for a small set of blanking. The punch is of the built-up type having a low-carbon steel, which is fitted in the press ram and a hardened cutting edge held by screws on to the base. The almost how a built-up punch of this type is two fold. It gives a strong edge that will withstand the abrasive action for a considerable period without losing its size, and it permits a great economy in the use of expensive alloy steel. In this particular design the cutting edge is held in position by means of a pin and hollow head screws.

of shape may be converted with out

To assist the clamping and make up the "shunt height" of the press, the bed is mounted on a bolster plate. It is located by means of strong dowels and clamped in position with hollow head screws.

In order to guide the material a guide plate fitted with a stop is attached to the face of the blank bed. The guide plate also acts as a stripper and takes the scrap coming off the punch. It aids in getting a good blank and a reasonable output per hour, as time is not wasted in having to pull the scrap clear by hand.

**Piercing:-** Also sometimes called punching the piercing is making holes in a sheet. It is identical to blanking except the fact that the punched-out portion coming out through the die is piercing is scrap.

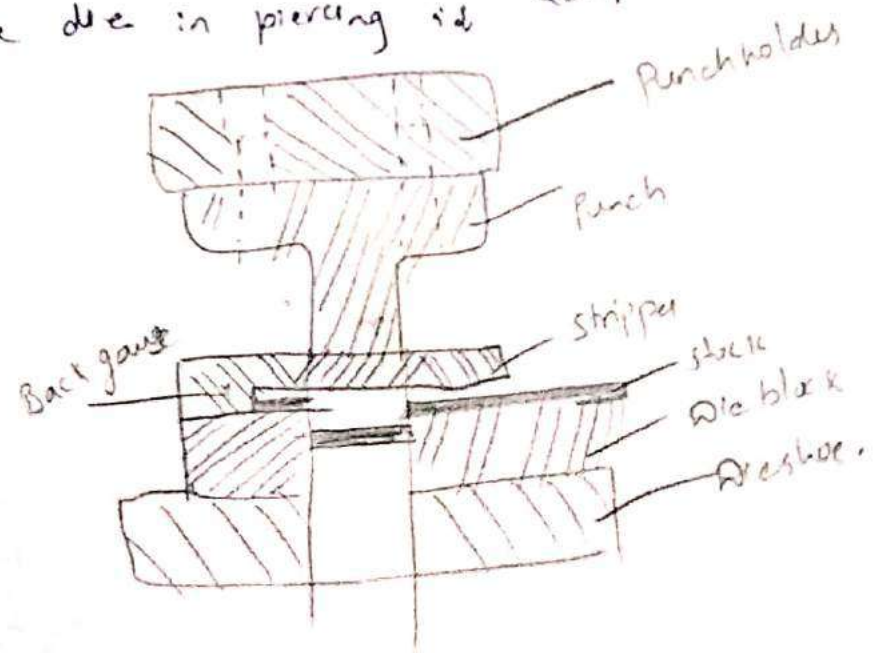

## Sheet Metal operations:-

Sheet metal forming is the process of converting a flat sheet of metal into a part of desired shape with out or excessive localized thinning. The process may be simple, such as a bending operation, or a sequence of very complex operations such as those performed in high-volume stamping plants.

**Sheet metal:-** Sheet metal is simply metal formed into a thin and flat piece called a "sheet metal".

→ In prehistoric times, metal sheets were used to make armor of soldiers, swords etc;

→ Before the discovery of glass, it was also used to make common home articles like plates, bowls, liquid jars etc;

Later on the sheet metal found its way in the making of vehicles, blades of helicopters.

### Sheet Metal characteristics:-

① **Elongation:-** This is the characteristic of the sheet metal to stretch with out necking and failure.

② **Strength:-** The ability of a material to stand up to forces being applied with out bending, breaking or deforming it in any way.

③ **Elasticity:-** The ability of a material to absorb force it in different directions, returning to its original position.

④ **Plasticity:-** The ability of a material to change in shape permanently.

⑤ **Ductility:-** The ability of a material to change shape (deform) usually by stretching along its length.

⑥ **Toughness:-** A characteristic of a material that does not break when receiving a blow or under a sudden shock.

## Defects in forging:-

- (1) Cold shut:- This usually occurs at the corners and right angles to the surface. This is caused mainly by the improper design of the die where in the corner and fillet radii are small as a result of which the metal does not flow properly into the corner and ends up as a cold shut.
- (2) Unfilled section:- It is similar to misrun in casting and occurs when metal does not completely fill the die cavity. It is usually caused by using insufficient metal or insufficient heating of the metal.
- (3) Flakes:- Basically these are internal ruptures. These are caused by improper cooling of large forging and can be remedied by following proper cooling practice.
- (4) Scale pits:- These are irregular depressions on the surface of the forging. These are primarily caused because of the improper cleaning of the stock used for forging.
- (5) Improper grain flow:- This is caused by the improper design of the die which makes the flow of metal not following the final intended directions.
- (6) Internal cracks:- These can result from too drastic a change in the shape of the raw stock at too fast a rate.
- (7) Die-shift:- This defect is caused by the misalignment of two die halves, making the two halves of the forging to be of improper shape.
- (8) Burnt and overheated metal:- This defect is caused by improper heating conditions and soaking the metal too long.

The ability of a material to conduct electricity.

ductivity:-

Tensile strength:- The ability of a material to stretch with out breaking.

Grain size:- Determines surface roughness on stretch sheet metal. It affects material strength.

### Applications of sheet Metal:-

1. In Automobiles:- The sheet metal is deformed into the desired and brought into the required form to get auto body pressing like bumpers, doors etc;

2. It is used for making the entire fuselage wings.

3. It is used for making many parts like washing machine body & covers, clock cases, fan blades, cooking utensils etc.

### Formability of sheet Metal:-

The ability of the sheet metal to undergo the desired shape change with out such failure as necking or tearing.

### Testing Methods for FORMABILITY:-

We can determine the

formability of sheet metal by following tests.

- ① DUCTILITY TEST
- ② BENT TESTER
- ③ TENSILE TEST
- ④ CUPPING TEST

① TENSILE TEST:- Tensile testing is the most basic mechanical test for sheet metal. This test is relatively simple & inexpensive. It also follows established standards to ensure uniformity of application and results suitable for comparison.

Simply put a standardized sample in tensile test apparatus and pull it along a single axis until it fails.

We measure the material as it is pulled to determine the materials elongation, tensile strength, yield strength.

CUPPING TEST:- The first test is the cupping test, which checks the formability of sheet metals. In which test sheet metal specimen is clamped between two circular dies, and a steel ball or round punch is pushed hydraulically into the sheet metal until a crack begins to appear on the stretched specimen.

Formability of sheet metal is directly proportional to the punch depth 'd'. This test is insufficient in simulating exact conditions of actual sheet-forming operations.

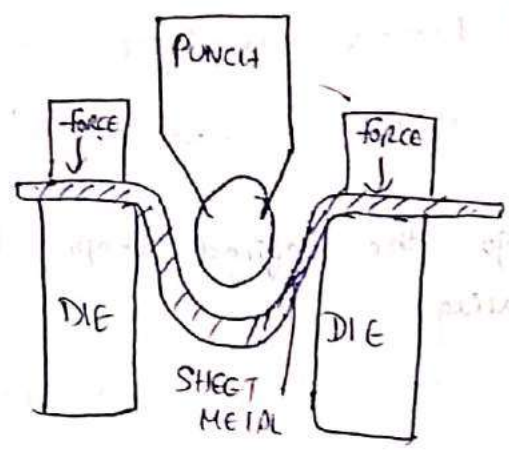

SHEARING OPERATIONS:-

General purpose shearing work, for example in cutting the small pieces from a larger sheet. But the more useful are the die-shearing operations where the shears take the form of the component to be made. The upper shear is called the punch and the lower shear is called a die. The two widely used processes are blanking and piercing.

① Blanking:-

Blanking is a process of cutting or shearing a blank from sheet or strip material.

(Or)

It is a process in which the punch removes a portion of material from the stock, which is a strip of sheet metal of the necessary thickness and width. The



Circular flat hydraulic test

Bending:-

Bending is the operation of deforming a flat sheet around a straight axis, where the neutral plane lies at its center. It is a very common forming process for changing sheet and plate into channel, drums, tanks etc.

The types of bending dies/methods are shown in figure.

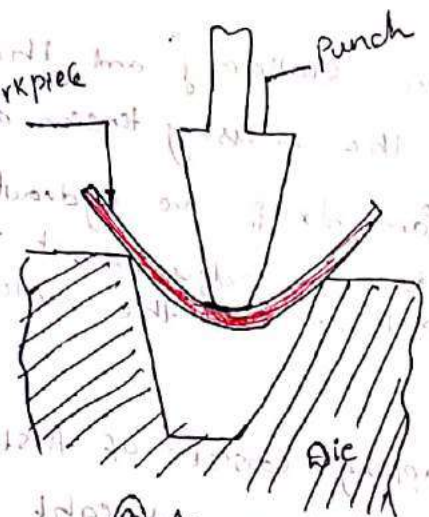

(a) Air-bending

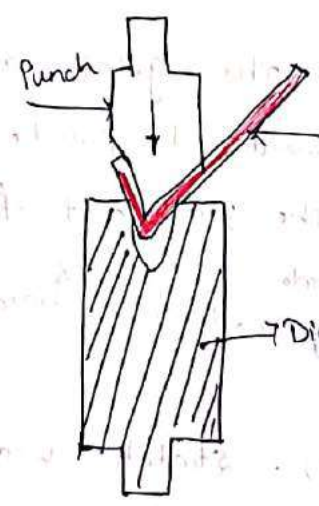

(b) Die-bending

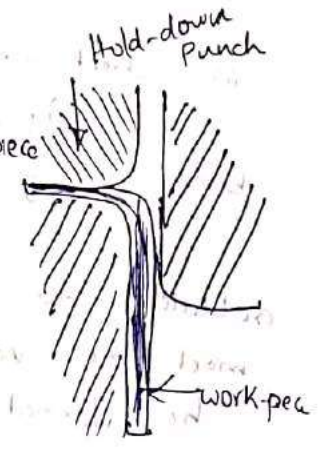

In V-bending, fig (a, b), a wedge-shaped punch forces the metal sheet or strip into a wedge shaped die cavity. The bend angle may be acute, 90° or obtuse.

V-dies are the ones that are most generally used.

Wiper bending is used for 90° bends only. Here the work is held firmly to the die, and the punch bends the extended portion of the blank.

Presses specifically designed for these operations are called press brakes.

The bending load may be calculated from the knowledge of material properties and die characteristics as follows:

$$P_b = \frac{KL \sigma_y t^2}{b}$$

where  $P_b$  = Bending force N.

$K = 1.33$  for die opening of  $8t$ ;  $1.20$  of  $16t$ ,  $0.67$  for U bending.

$l$  = length of bent part, mm.

$\sigma_u$  = ultimate tensile strength, MPa.

thickness, mm and  $b$  = width b/w contact points mm.

Stretch forming: It is a method of producing

in sheet metal.

Fig (a) The grips are stationary and the form block moves upwards to provide the necessary tension and motion. The jaws and form blocks are hydraulically actuated to provide control of pressure adjustment to meet the varying conditions characteristic of the material to be formed.

Fig (b) stretch wrapping consists of first stretching the metal beyond yield point while it is straight and then wrapping it around a form block. It is particularly suited for long sweep bends or tubes and embedded shapes.

The main advantage of this type of forming is that only one die is needed, the die may be made out of inexpensive material.

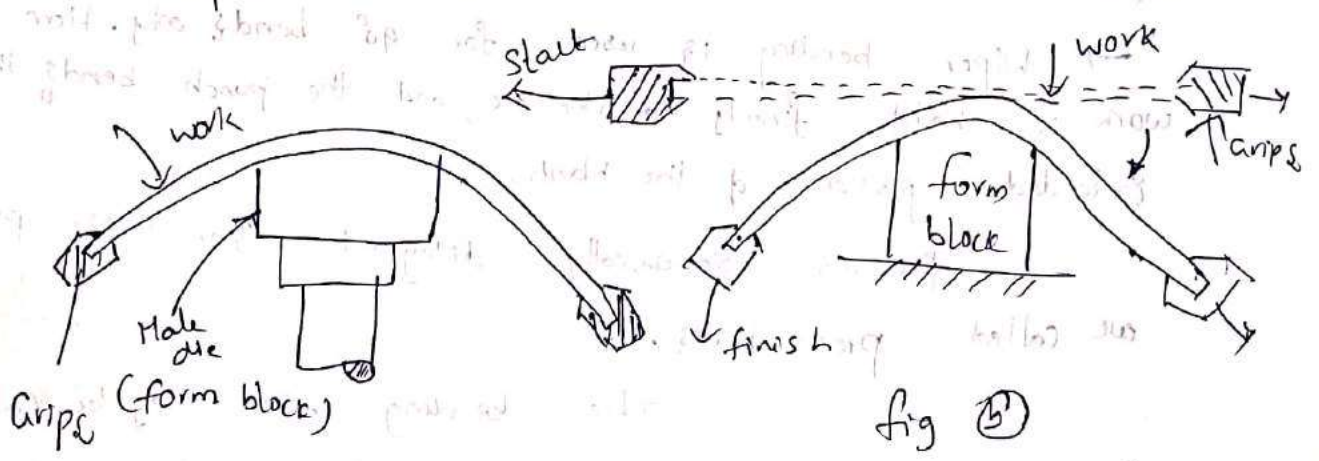

Fig (a)

The thickness reduction should not exceed 5% of the original thickness.

The process is applicable to a wider range of materials, because the ductility is the least important

Layer  
d = 3 mm  
er

Shock transmission.

Explosive forming is widely used, high-rate forming technique for large and difficult geometries. This process was mostly used to form large and bulky components typically for military and aerospace applications.

A few ex of products manufactured using explosive forming are: Jet engine shroud, many unique tubular shapes, Composite tubes, nozzles.

Adv:- (1) low tooling cost. (2) Simpler tooling as only one-sided tooling is required. (3) unlimited power. (4) Suitable for low-quantity production.

Typical alloys that are used for explosive forming are aluminium alloys, titanium & Ti alloys and nickel based super alloys.

Explosive forming process also called the Explosive is employed to generate shock waves to directly deform the work piece at very high velocities. There are 2 types of possibilities.

It is a very high energy - rate manufacturing process (HERF). An explosive is employed to generate shock waves to propagate which is difficult and

1) Stand off Method:- In this method, the explosive is at a specified distance from the work piece where the energy from the explosive is transmitted through a medium (usually water) to deform the work piece as shown in fig. The working times are normally measured in milliseconds and the work piece velocities are measured in terms of 100 m/s.

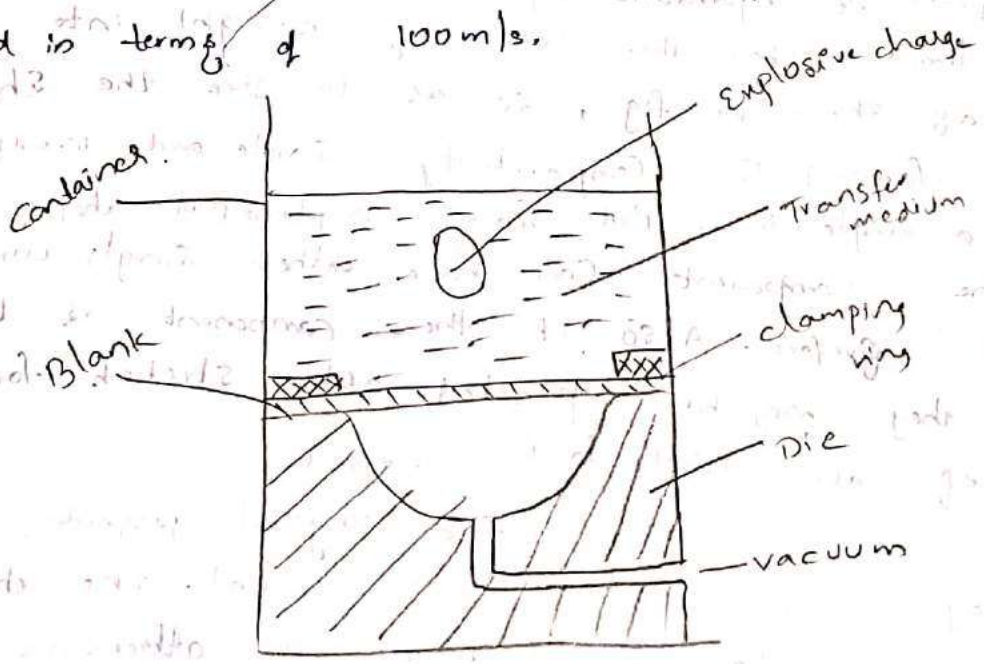

2) Contact Method:-

In contact method, the energy is released while the explosive charge is directly in contact with the work piece. The expected interface pressures acting on the surface of the material will experience high intensity transient shock waves. These shock waves while propagating through the material deform it to the required shape of the die.

As shown in fig, the set-up for explosive forming involves a die, the blank and an explosive charge contained in a medium for stand-off method. Evacuation of the die is usually required because of the high speed of operation especially if close tolerances are required. Although explosive forming is possible in air, doing it with a dense transfer medium such as oil or water provides the advantage of

factor in stretch forming.

**Stretch forming:** In all the processes the deformation of the metal is done in elastic and plastic range, the spring back is always to be considered. However in stretch forming the complete deformation is carried out in plastic state only. The material is first brought into plastic state by stretching, hence the name stretch forming.

In this process, the sheet is held in the jaws of hydraulic cylinders and is stretched beyond elastic limit. Then the sheet is brought into contact with the die as shown in fig, so as to give the shape of the die. Stretch forming is comparatively simple and inexpensive, because it uses a single die. But many complicated shapes cannot be obtained. But the component can have either singly curved or doubly curved surface. Also, if the component is to have any holes, they may be punched after stretch forming, otherwise the holes are likely to be enlarged.

The physical properties are generally improved by uniform stretching of the metal. The sheet used in stretch forming should have uniform thickness, otherwise the thinner portions are likely to be overstretched.

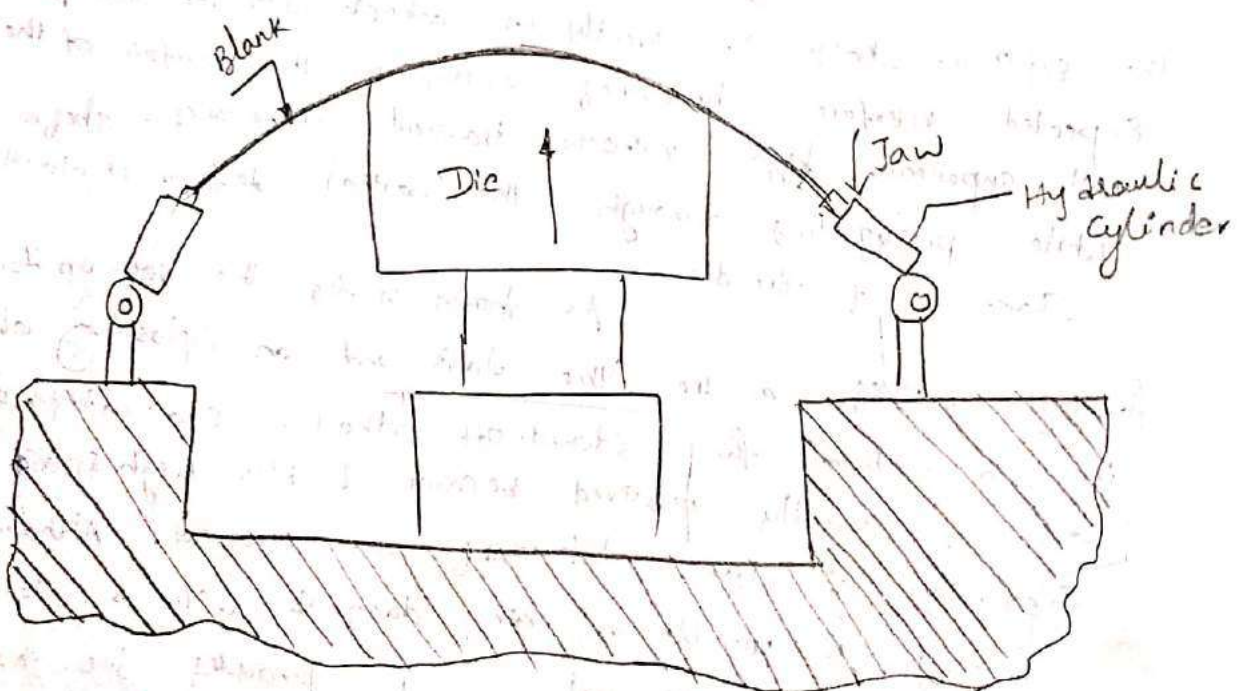



**SREENIVASA INSTITUTE OF TECHNOLOGY AND  
MANAGEMENT STUDIES**

**CHITTOOR, ANDHRA PRADESH- 517127**

**AN ISO 9001:2015 CERTIFIED INSTITUTION**

**(AUTONOMOUS and ACCREDITED BY NAAC & NBA, PERMANENTLY AFFILIATED TO JNTU ANANTHAPURAMU)**

**DEPARTMENT OF MECHANICAL ENGINEERING**

NOTES FOR

**MANUFACTURING TECHNOLOGY**

**UNIT-V**

**POWDER METALLURGY**

# UNIT-5 POWDER METALLURGY

Powder metallurgy is defined as the art of making objects by the heat treatment of compressed metallic powders.

Steps involved in Powder Metallurgy process:-

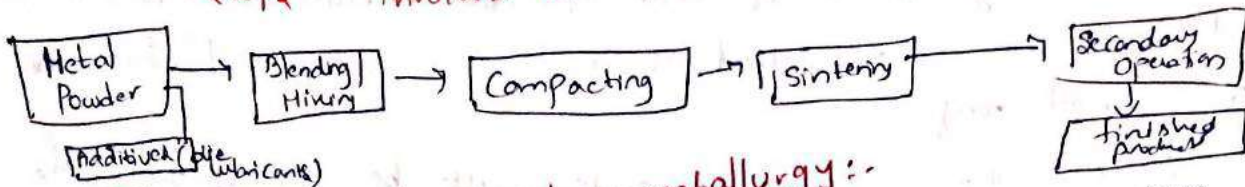

Advantages of powder metallurgy:-

- ① Such parts which have special properties can be produced which otherwise cannot be obtained.
- ② Machining operations are eliminated.
- ③ Scrap losses are reduced and often results in lower unit cost for a given part in comparison to any other production method.
- ④ Metals and alloys can be mixed together in any proportion which is difficult and sometimes not possible by melting.
- ⑤ Metals and non-metals can be mixed together in any proportion.
- ⑥ There is better control of composition and structure of the component by this process.
- ⑦ Articles of any desired porosity can be manufactured.
- ⑧ Super-hard cutting bits, which can never be manufactured by any other methods are made by powder metal.  
Ex: Sintered Carbides.
- ⑨ This process is suitable for mass production because the stroke of the pressing (or) Compacting consists of press at a speed of 60 strokes/minute.
- ⑩ The process is very economical and the loss material is lesser as compared to other processes.

⑪ Diamond impregnated tools for cutting porcelain, glass and tungsten Carbides are made possible only by powder Metallurgy.

### Disadvantages:-

① Owing to the fairly high compacting pressures required to press the powder, the wear on the dies is high.

② Due to high rate of wear of dies, high costs for dies and presses the method is rendered uneconomical particularly for small runs.

③ Since the compacted parts must be ejected from the die without fracture, therefore, the shapes that may be made by this method are limited.

④ Equipments required are very costly.

⑤ A complex dense product is not possible without heating the product after pressing operation.

⑥ The physical properties obtained by this process are lower than those obtained by other processes.

⑦ In the low melting powders like tin, zinc and cadmium, sometimes certain thermal difficulties appear.

⑧ The intricate shapes cannot be made by compacting since metal powders cannot flow like fluid under compact load.

⑨ The products are of small size because for larger size bigger equipments and tools would be necessary involving very heavy investment.

⑩ Many metal powders are explosive at room temperatures.



- Applications of Powder Metallurgy:-
- ① Porous and graphite containing metal bearings.
  - ② Tungsten wires
  - ③ Rotors of gear pump
  - ④ Magnetic Materials
  - ⑤ Diamond impregnated tools
  - ⑥ Metal to glass seals
  - ⑦ Motor brushes
  - ⑧ Metallic filters
  - ⑨ Metallic Coatings
  - ⑩ Cemented Carbides
  - ⑪ Friction Materials

Characteristics of powder Metallurgy:-

- ① Particle shape:- The particle shape depends largely on method of powder manufacture. The shape may be angular, dendritic, irregular. The particle shape influences the flow characteristics of powder.
- ② Particle size:- The particle size influences the control of porosity and amount of shrinkage. It is determined by passing through microscopic measurement.
- ③ Particle size distribution:- It influences the packing of powder and its behaviour during moulding.
- ④ Compressibility:- It is defined as volume of initial powder to volume of compact part.
- ⑤ flow rate:- It is the ability of powder to flow readily and conform to the mould cavity. It determines rate of production and accuracy.
- ⑥ purity:- Metal powders should be free from impurities, as the impurities reduce the life of the dies.
- ⑦ Apparent density:- It depends on particle size and is defined as ratio of volume to weight of loosely titted mixture.

# Manufacture of Metallic Powders:-

The first step in all the PH process is making metal powders. There are a number of processes used -B.

- the manufacture of metal / alloy powders.
- ① Atomisation
  - ② solid-state reduction
  - ③ electrolysis
  - ④ chemical.

① **Atomisation:-** 1. Atomisation breaks molten metal into small droplets by rapidly freezing, before the droplets come into contact with each other or with a solid surface.

2. In this method, molten metal is forced through a small orifice and is disintegrated by a powerful jet of compressed air or inert gas (or) water.

3. Air, Nitrogen and argon are commonly used gases and water is the liquid most widely used.

4. In Atomisation, the particle shape is determined largely by the rate of solidification and varies from spherical, if a low-heat-capacity gas is employed, to highly irregular

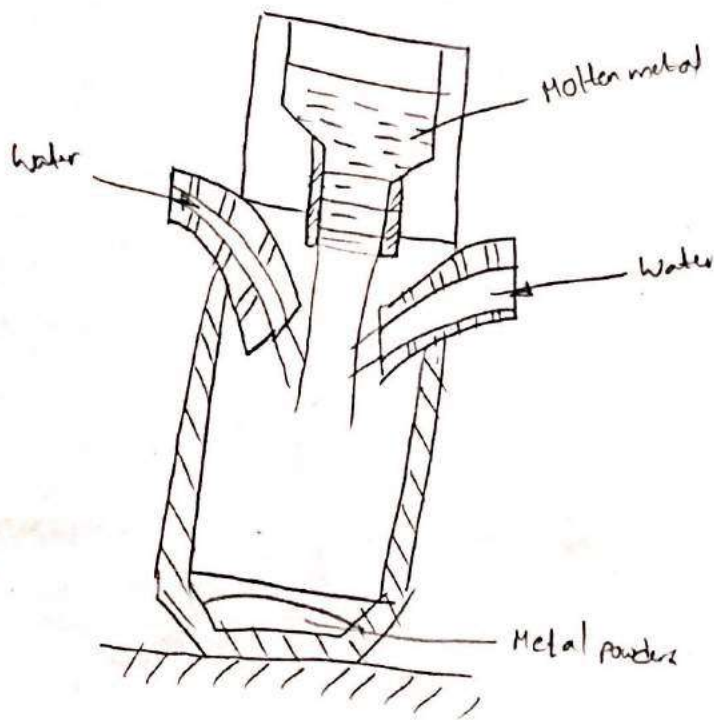

fig (c) Atomisation using water stream to produce Metal powder.

fig (c) shows the atomisation process similar to (b) except high-pressure water jet is used in place of gas. Water provides higher cooling rate, however the particles produced are not spherical, but are irregular in shape. one disadvantage of using water is that the surface of the powder particles get oxidised. This can be taken care of by using synthetic oil in place of water.

## 2. Solid-state Reduction:-

This process is generally used for producing iron powder. In this process, the selected metal/alloy is crushed, mixed with carbon and passed through a continuous furnace where a reaction takes place, which leaves a cake of sponge metal. This sponge metal is then crushed after separating from all non-metallic material. Then it is sieved to produce powder. The purity of powder is dependent on the purity of the raw materials. The powder particles are irregular and sponge like which can be readily compressed to give good strength.

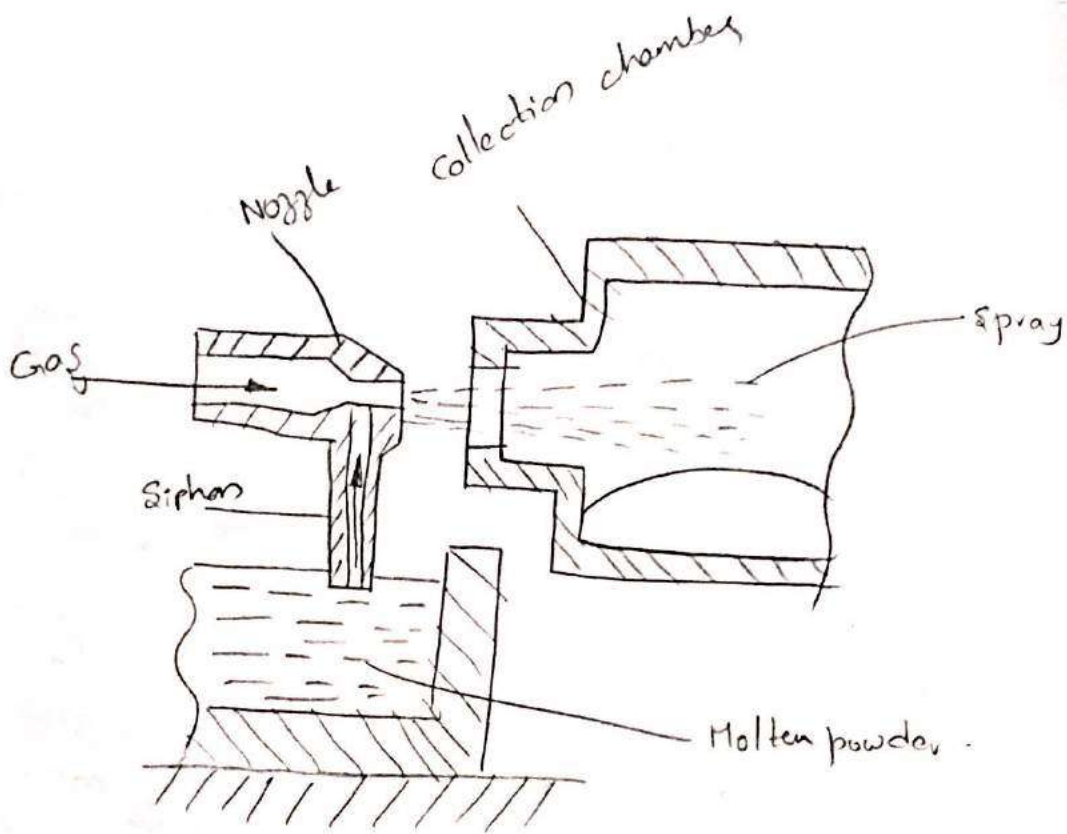

fig. Atomisation using a gas stream

to produce metal powder.

Another variation of the gas atomisation process is shown in fig (b). The molten metal flows by gravity into a thin stream, which is immediately atomised by the high-pressure gas jets coming from both sides, then by forming ~~spherical~~ spherical particles, which are then collected in the collection chamber.

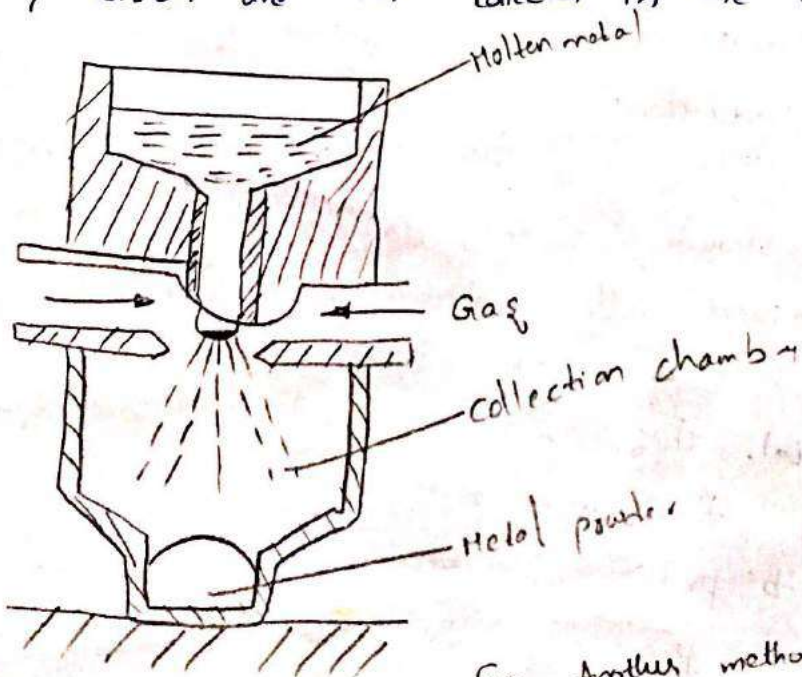

fig. Another method of atomisation using a gas stream to produce metal powder.

The desired metal is made as anode in an electrolytic cell such that it is dissolved by the electrolyte in the cell and then transported and deposited on the cathode in a spongy or powdery form. The deposit is removed, washed and dried to get the metal powder.

Copper is the primary metal produced by electrolysis but iron, chromium and magnesium powders are also produced using this process.

## ② Mixing and Blending:-

Generally, a single metallic powder may not have all the requisite properties required for a part. Hence, a number of different powders with the requisite properties are mixed to achieve the necessary balance of the properties.

Blending refers to the mixing of the same metal or alloy powders of different size distributions to reduce the porosity levels in the P/M product. The powders are also mixed with other additives to help with the alloying process as well as lubrication.

The main function of the lubricant is to reduce the friction between the powder and the die walls, core rods, etc., where the powder slides during the compaction process. This ensures that the desired uniformity of density from top to bottom of the compact. The lubricant will also help in reducing the friction for easy ejection of the compact and minimize the tendency to form cracks.

Popular lubricants are stearic acid, stearin, metallic stearates and increasingly, other organic compounds of a waxy nature.

Blending and mixing is normally done by using mechanical processes. Typically, the mixing machines will be rotating drums in which the powder is loosely filled to the extent of about 20 to 40% of the volume. It may have internal baffles to help throwing the powder away so that there will be

overmixing should be avoided, as it will increase the apparent density of the mix. Also, overmixing usually reduces green strength of subsequent compacts probably by completely coating the whole surface of the particles, thereby reducing the area of metal-metal contact on which the green strength depends.

The process of blending is carried out for the following purposes:-

- (1) To obtain uniformity (since the powder processes may have different sizes & shapes).
- (2) To impart special physical and mechanical characteristics to the powder metallurgy product.

Compacting:-

## Plastic:-

A plastic is defined as any non-metallic material that can be moulded to shape.

Most of the plastics are of organic nature composed of hydrogen, oxygen, carbon & Nitrogen.

### Classification of plastic:-

- ① Thermoplastic      ② Thermosetting.

① **Thermoplastic materials:-** The plastics which soften on the application of heat with or without pressure but require cooling to set them to shape are called thermoplastic materials.

These can be heated and cooled any number of times only they should not be heated above their decomposition temp.

They are mainly long chain, straight or slightly branched molecules and the chains are held close to each other by secondary weak forces of type Vander waal's forces.

They are highly plastic and are easy for moulding or shaping.

They have low melting temp and not so strong as the thermosetting plastics.

Important thermoplastic materials are:

- (i) polythene ( $C_2H_4$ )<sub>n</sub> (or) polyethylene      ② polyvinyl chloride (PVC)  
③ Polypropylene (PP)      ④ polystyrene      ⑤ Teflon      ⑥ Bitumen  
⑦ silicones.

② **Thermosetting materials:-** 1. The plastics which require heat and pressure to mould them into shape are called thermosetting materials.

2. They cannot be resoftened once they have set and hardened.

3. They are ideal for moulding into components which require rigidity, strength and some resistance to heat.

4. Thermosetting resins have 3-D molecular structure.

Important thermosetting materials are:

- ① phenol formaldehyde (PF) - "Bakelite".
- ② polyester
- ③ Epoxy resin.

### Characteristics / Properties of plastics:-

① **Specific gravity:-** plastics are generally light having specific gravity between 0.9 to 3.0 compared to 3.0 to 12.00 for metals.

② **Specific heat:-** specific heat is the heat necessary to raise the temperature of 1kg substance by 1K.

③ **Thermal conductivity:-** plastics have comparatively low thermal conductivity, hence they are good thermal insulating materials, particularly expanded.

④ **Thermal expansion:-** Thermal expansion of plastics is very high (approx. 5 times thermal expansion of aluminium)

⑤ **Electrical properties:-** plastics are good electrical insulators. However their usefulness is limited by their low heat resistance and softness.

⑥ **Corrosion resistance:-** plastics are generally resistant to most inorganic chemicals, weathering and soil. However, most plastics become brittle and yellow when exposed to sunlight for long duration. plastics are resistant to attack by oils and greases, hence superior to rubber.

⑦ **Combustibility:-** plastics are combustible because of presence of carbon. The max service temp is about 100°C.

⑧ **Rigidity:-** plastics have low rigidity compared to other materials, since they have low modulus of rigidity.



Blow Moulding

• narrow neck plastic articles.

This process is used for producing containers, like bottles and similar others.

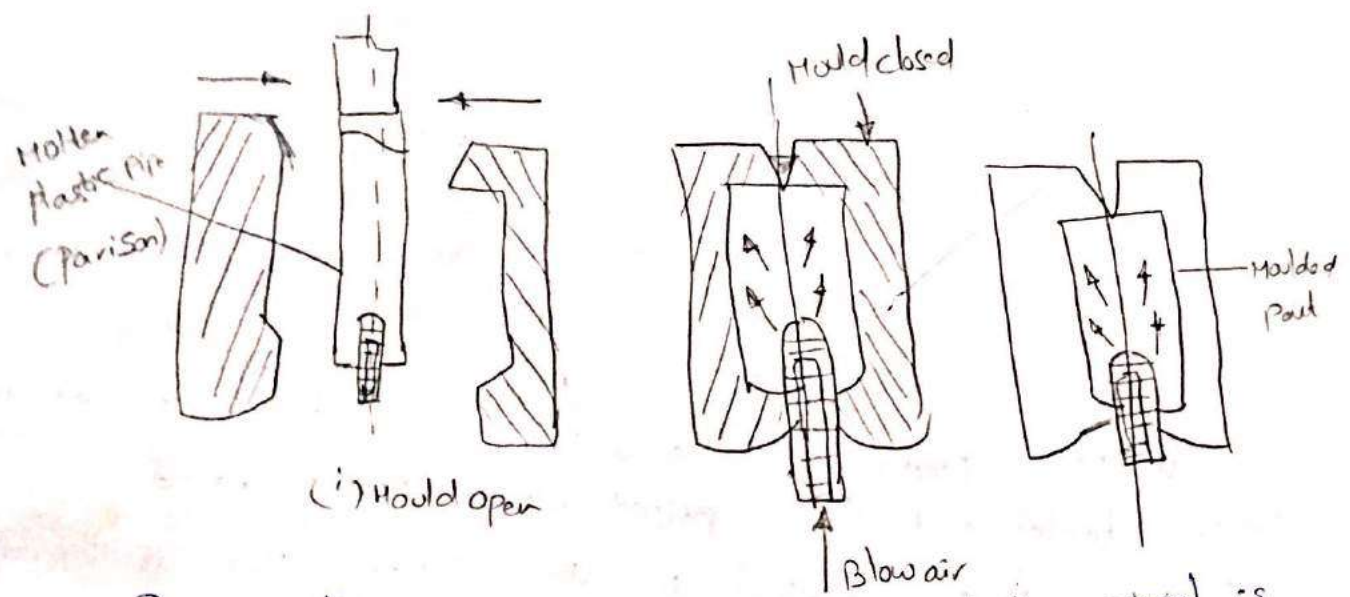

In blow molding, a hot tube of plastic material is placed between two halves of the mould. The mould is closed and air or non-reactive gas like argon is blown under a pressure of 20-40 MPa which expands the hot tube outwardly to fill the mould cavity. The mould is then opened and the product, hollow in shape, is removed from the mould.

It is used for fast and cheap production. This can be done manually or by automatic and semi-automatic machinery.

Adv:-

- ① High production rate
- ② Hollow shapes of various sizes with thin walls can be produced.
- ③ Low cost for making hollow shapes.

Limitation:-

Limited to production of hollow shapes.

intricate shapes can be formed in these cavity moulds.

The articles can be removed by opening the moulds.

(3) The shape of the component is almost in its final form and can be produced in an extremely fast rate. Typical cycle times may be of the order of 10 to 30 seconds.

(4) Unlike molten metal in die casting, plastic melts have a high viscosity and have to be injected with a large force into the hollow mould cavity. More melt should also be packed into the mould during solidification to avoid shrinkage in the mold. Injection moulding pressures usually range from 70 MPa to 200 MPa.

(5) Injection moulding is the most widely used plastic-processing method. It can be used to produce a wide variety of products. Very complex parts can be produced whose sizes may range from very small 50g to very large 25kg.

With excellent control of tolerances. Most polymers may be injection moulded, including thermoplastics, fibre reinforced thermoplastics, thermosetting plastics and elastomers. Reaction injection moulding and liquid injection moulding which differ in the manner of mixing ingredients, involve the injection of liquid polyurethane systems that polymerise within the mould.

Moulds with moving and unscrewing Mandrels are not unusual, and allow the moulding of parts with multiple cavities and internal & external threads.

Metallic inserts such as screws, pins and strips can also be placed in the mould cavity to become an integral part of the injection-moulded part.

The following methods are used to inject the molten plastic into the mould:

- (1) Reciprocating and rotating screw injection moulding
- (2) plunger injection moulding.

Limitations:- (1) High tooling cost (2) High volume production is

# Thermoforming process:-

Thermoforming is a process of shaping flat thermoplastic sheet which includes 2 stages. Softening the sheet by heating followed by forming it in the mold cavity. elastomers and thermosets cannot be formed by the thermoforming methods because of their cross-linked structure.

Thermoplastics which may be processed by the thermoforming method are polypropylene (PP), polystyrene (PS), PVC, low density polyethylene (LDPE), HDPE, poly methyl methacrylate.

Thermoforming is widely used in the food packaging industry for manufacturing ice cream and margarine tubs, snack trays, sandwich packs etc.

- There are 3 thermoforming methods,
- ① vacuum thermoforming
  - ② pressure thermoforming
  - ③ Mechanical thermoforming.

**① Vacuum Thermoforming:-** The process involves shaping a preheated thermoplastic sheet by means of vacuum produced in the mold cavity space. The atmosphere pressure forces the soft sheet to deform in conformity with the cavity shape. When it cools down and hardens, it comes into the contact with the mold surface.

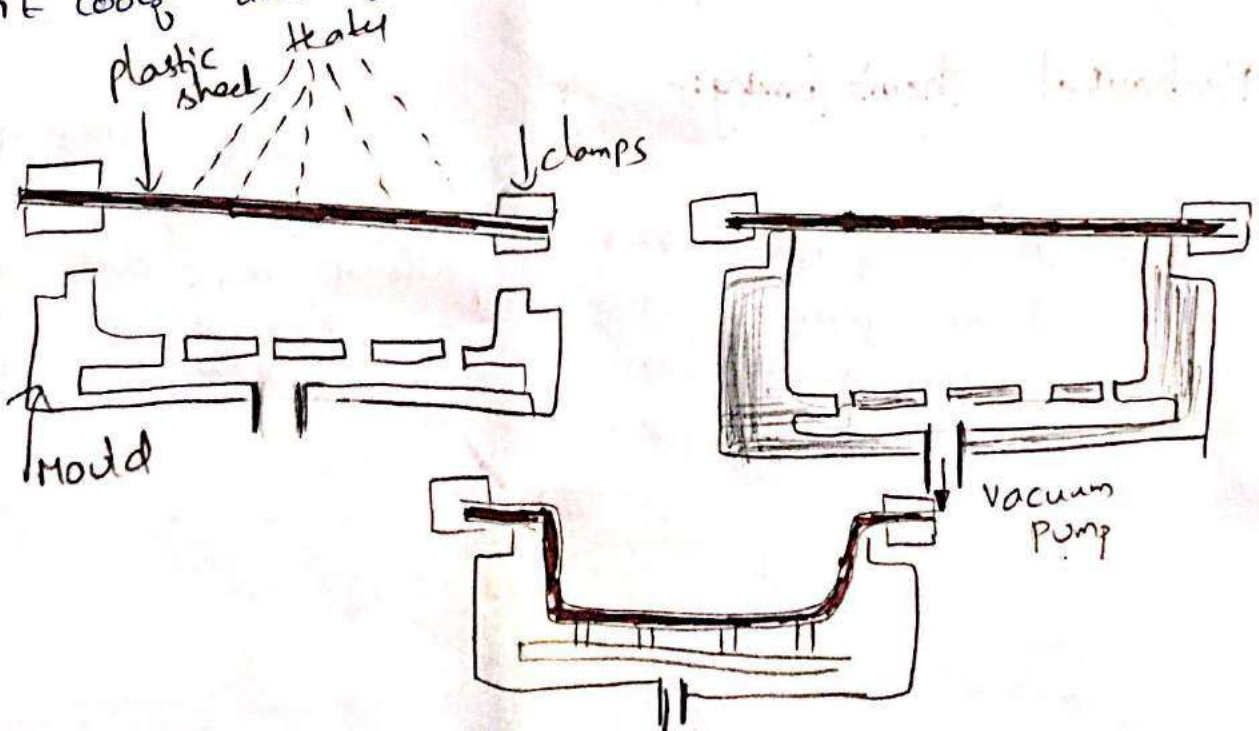

② pressure thermoforming

The process involves shaping a preheated thermoplastic sheet by means of air pressure. The air pressure forces the soft sheet to deform in conformity with the cavity shape. When the plastic comes into the contact with the mold surface, it cools down and hardens.

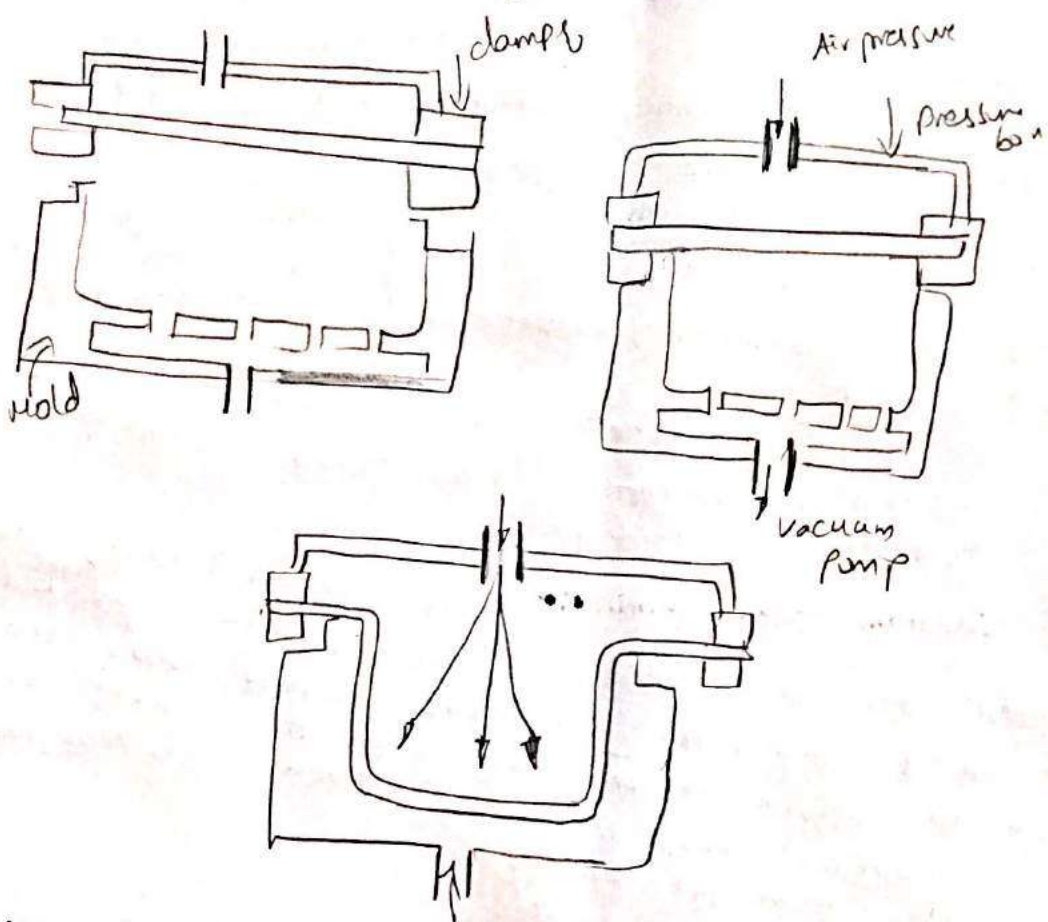

Mechanical Thermoforming:-

The process involves shaping a preheated thermoplastic sheet by means of a direct mechanical force. A core plug (positive mold) forces the ~~soft~~ soft sheet to fill the space b/w the plug & negative mold. The process provides precise dimensional tolerance & surface details.

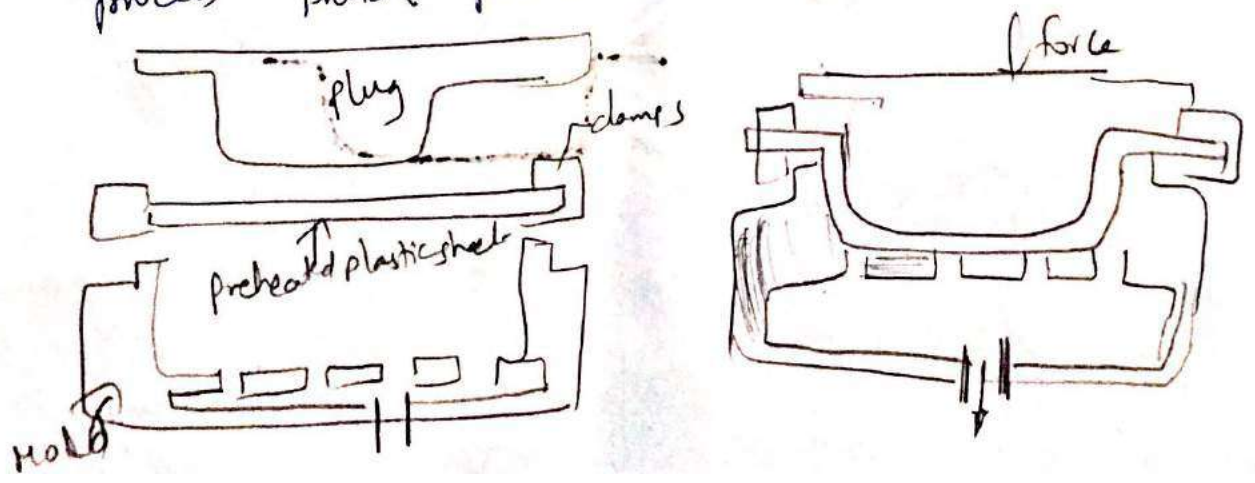

# Rotational Moulding :-

Rotational moulding uses gravity inside a rotating mold to achieve a hollow form. Also called rotomoulding, it is an alternative to blow moulding for making large hollow shapes. It is used principally for thermoplastic polymers but applications for thermosets and elastomers are becoming more common. Rotomoulding tends to favor more complex external geometries, larger parts, and lower production quantities than blow moulding.

The process consists of the following steps:-

- ① A predetermined amount of polymer powder is loaded into the cavity of a split mold.
- ② The mold is then heated and simultaneously rotated on two perpendicular axes, so that the powder impinges on all internal surfaces of the mold, gradually forming a fused layer of uniform thickness.
- ③ While still rotating the mold is cooled so that the plastic skin solidifies.
- ④ The mold is opened, and the part is unloaded.

Rotational speeds used in the process are relatively slow. It is gravity, not centrifugal force, that causes uniform coating of the mold surface.

Moulds in rotational moulding are simple and inexpensive compared to injection or blow moulding but the production cycle is much longer, lasting perhaps 10' min or more. To balance these advantages and disadvantages, rotational moulding is often performed on a multicavity indexing machine, such as the 3-station machine shown below.

The machine is designed so that three molds are indexed in sequence through three work stations. Thus all three molds are working simultaneously. The first workstation is an unload-load station where the finished part is unloaded from the mold, and the powder for the next part

— R. moulding is done.

is loaded into the cavity. The second station consists of a heating chamber where hot-air convection heats the mold while it is simultaneously rotated. Temp inside the chamber are around 700°F, depending on the polymer and the item being molded. The third station cools the mold, using forced cold air or water spray to cool and solidify the plastic molding inside.

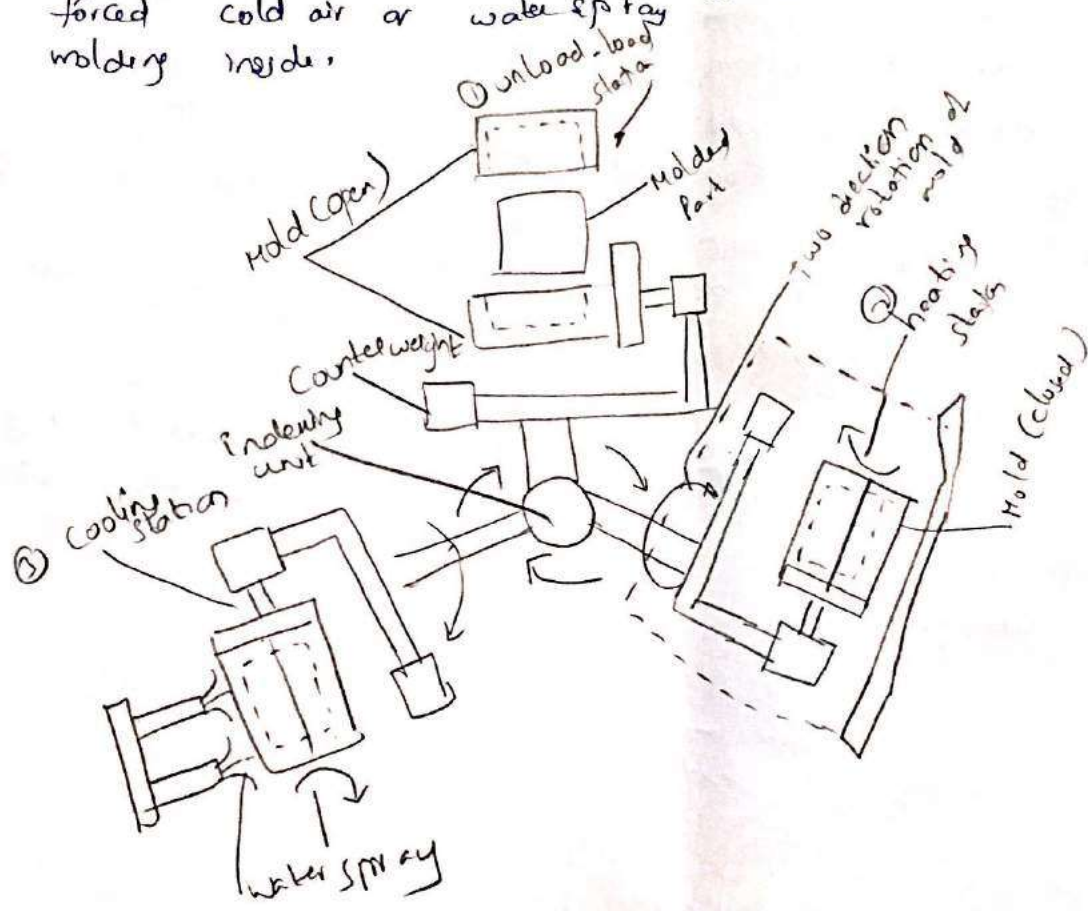

Rotating molding cycle performed on a 3-station indexing machine ① unload - station ② heat and rotate mold ③ cool the mold.

Many articles are made by rotational molding. They are playing balls, boats, sand bowls, fuel tanks, furniture, containers and storage tanks, automotive dash boards etc,

# Compression moulding process:-

It is an old and widely used moulding process for thermosetting plastics. Its applications also include thermoplastic phonograph records, rubber tires and various polymer matrix composite parts. The process consists of

- ① Loading a precise amount of molding compound, called the charge into the bottom half of a heated mold.
- ② Bringing the mold halves together to compress the charge, forcing it to flow and conform to the shape of the cavity.
- ③ Heating the charge by means of the hot mold to polymerize and cure the material into a solidified part.
- ④ Opening the mold halves and removing the part from the cavity.

- Compression moulding for thermoplastics:
- ① charge is loaded
  - ② charge is compressed and cured
  - ③ opening the mold halves and removing the part from the cavity.

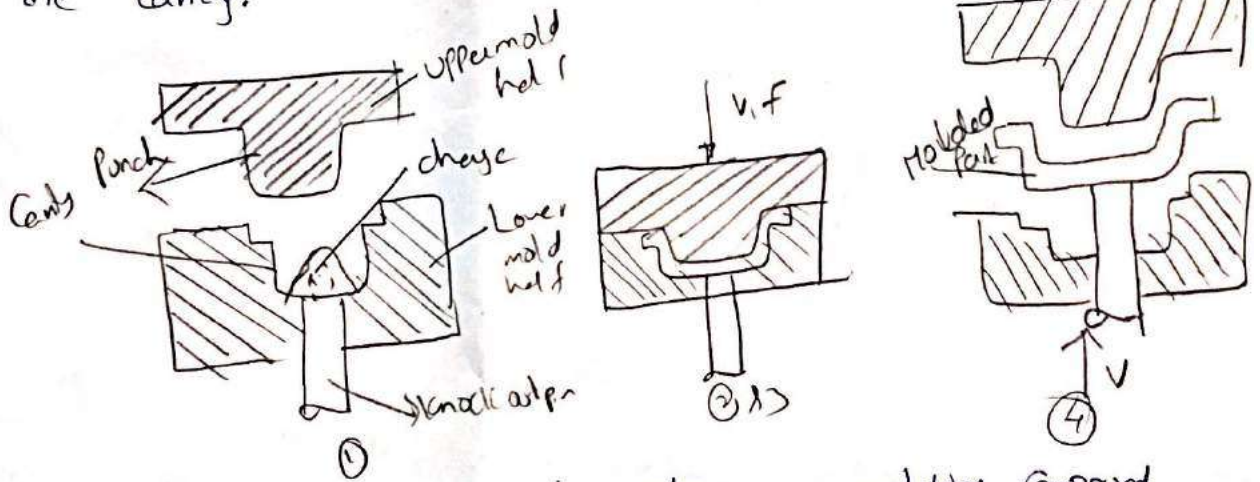

The initial charge of molding compound can be in any of several forms, including powders or pellets, liquids. The amount of polymer must be precisely controlled to obtain repeatable consistency in the molded product. It has become common practice to preheat the charge prior to its placement into the mold. This softens the polymer and shortens the production cycle time. Preheating methods include infrared heating, convection heating in an oven, and use of a heated rotating screw in a barrel.

Compression moulding presses are oriented vertically and contain two platens to fasten the mold halves. The presses involve



either of two types of actuation (1) upstroke of the bottom platen or (2) downstroke of the top platen. They are generally powered by a hydraulic cylinder that can be designed to provide clamping capacities up to several hundred tons. Holds for compression molding are generally simpler than their injection mold counterparts. There is no sprue and runner system in a compression mold, and the process itself is generally limited to simpler part geometries due to the lower flow capabilities of the starting materials. However, provision must be made for heating the mold, usually accomplished by electric resistance heating, steam.

Compression molds can be classified as hand molds used for trial runs, semi-automatic in which the operator manually loads and unloads the press and automatic, which operates under a fully automatic press cycle.

Materials for this molding include phenolics, melamine, elastomers. Typical TS plastic moldings include electric plugs, sockets, pot handles, dinnerware plates etc.

Adv:- (1) Holds are simpler, less expensive, (2) low maintenance, (3) less scrap, & low residual stresses

In the molded parts.

Dis:- larger cycle times, and therefore lower production rates.

### Transfer molding process:-

In this process, a thermosetting charge is loaded into a chamber immediately ahead of the mold cavity, where it is heated, pressure is then applied to force the softened polymer to flow into the heated mold where curing occurs. There are two variants of the process.

(a) pot-transfer molding - in which the charge is injected from a "pot" through a vertical sprue channel into the cavity and (b) plunger transfer molding in which the charge is injected by means of a plunger from a heated well through lateral channels into the mold. In both cases, scrap is produced each cycle in the form of the leftover material in the base of the well and lateral channels, called the cull. In addition, the sprue is scrap material. Because the polymer

are thermosetting, the & Clap cannot be recovered.

Transfer moulding is closely related to compression moulding, because it is utilized on the same polymer types. It is capable of molding part shapes that are more intricate than compression molding but not as intricate as injection molding. Transfer molding also lends itself to molding with inserts in which a metal or ceramic insert is placed into the cavity prior to injection, and the heated plastic bonds to the insert during molding.

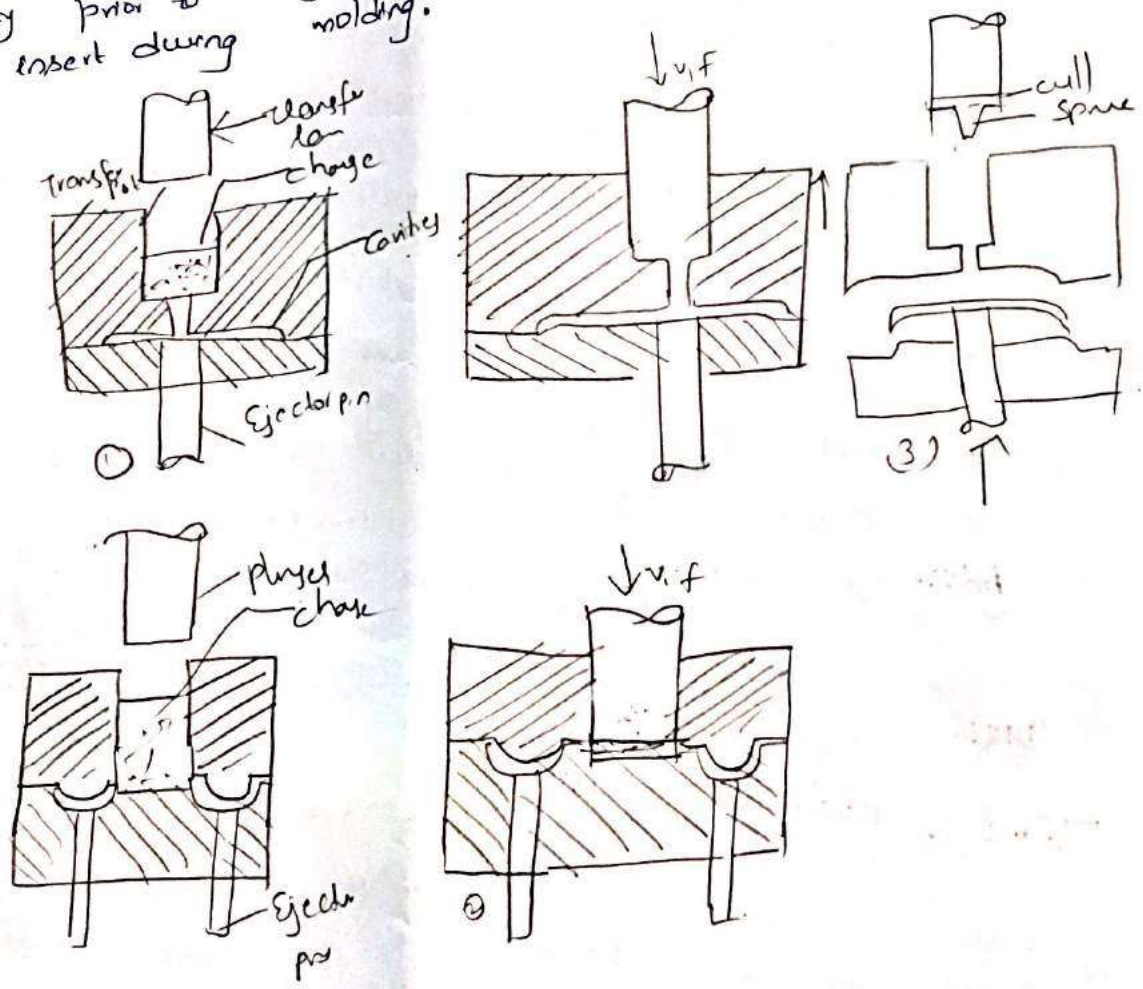

Ⓐ pot transfer molding both processes is polymer is pressed into is ejected.  
 Ⓑ plunger transfer molding, cycle is loaded into pot Ⓒ softened and cured. (3) part

## Designing for P/M:-

Because of the nature of the Powder-metallurgy process, it is important that the parts should be properly designed to take advantage of the process characteristics. The following are some of the guidelines:

- ① The geometry of the part should be such that the part can be easily ejected from the die. No draft is required. Perpendicular side walls and holes, parallel to punch travel are required. Holes can be any shape including cylindrical as long as they remain parallel to the axis of the punch travel.
- ② Choosing the wall thickness needs careful consideration. Long thin walls are difficult to produce. Long walls with a length to thickness ratio exceeding 8 to 1 should be avoided.
- ③ Undercuts on the horizontal plane as shown in fig (a) cannot be produced. If required, it needs to be produced with out the undercut and then machined as a secondary operation, as it inhibits part ejection. If an undercut is required at the junction as shown in fig (b) the alternative is to press a semicircular groove at the horizontal portion of the junction as shown in fig (b).

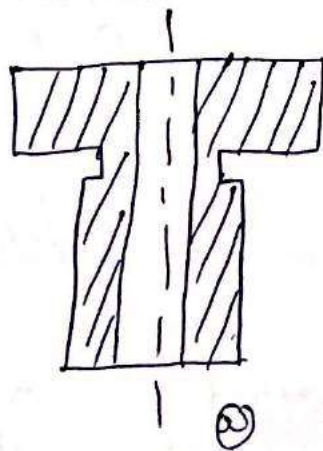

(a) undercut needs to be machined

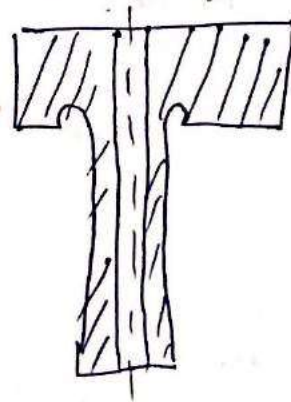

(b) undercut parallel to the punch movement can be produced.

Abrupt changes in section should be avoided, since they introduce stress raisers, which may lead to crack formation because of the stresses induced by the elastic expansion or spring back that takes place as the compact is ejected from the die.

Ideally, the part should have a uniform cross-section. However, when parts that have different cross sections, achieving uniform density is a problem. Hence maximum number of levels in the part should be limited depending upon the type of equipment used. For example in fig (a), the part has four levels. To get uniform density, it will require four punches which is not possible. Here the part will be modified as shown in fig (b) with two levels produced by the powder metallurgy process and a machining operation if added which will remove the lower two levels.

Screw threads cannot be produced and hence will be machined after the powder-metallurgy processing.

Tooling with generous fillets tends to last longer and result in higher component manufacturing speeds and greater tool integrity.

Table: Tolerances achievable after pressing and sintering.

Length ( $\pm$ )	Practical, mm	
	Practical, mm	Possible, mm
Inside diameter ( $\pm$ )	0.190	0.130
Outside diameter ( $\pm$ )	0.100	<del>0.050</del>
Concentricity ( $\pm$ )	0.100	0.050
Flatness on ends ( $\pm$ )	0.150	<del>0.100</del>
Parallelism of ends ( $\pm$ )	0.130	<del>0.100</del> 0.100

\* Compacting :-

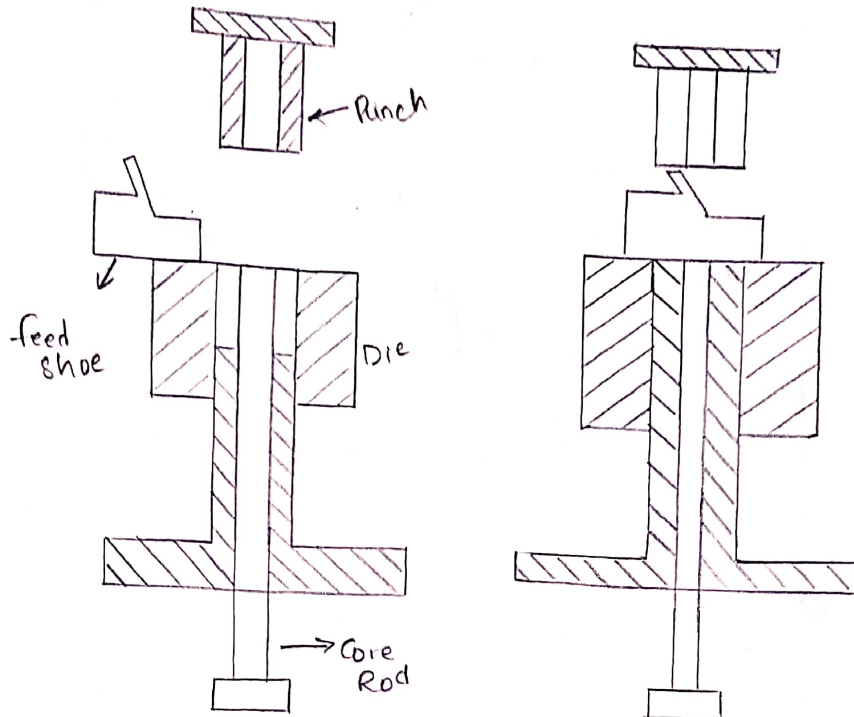

(a)

(b)

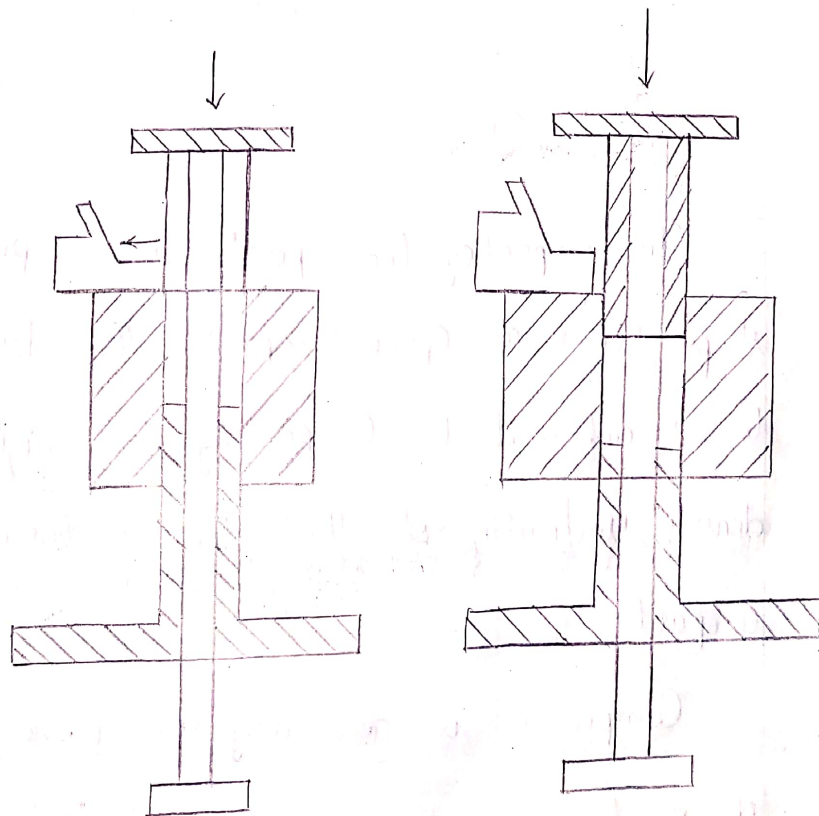

(c)

(d)

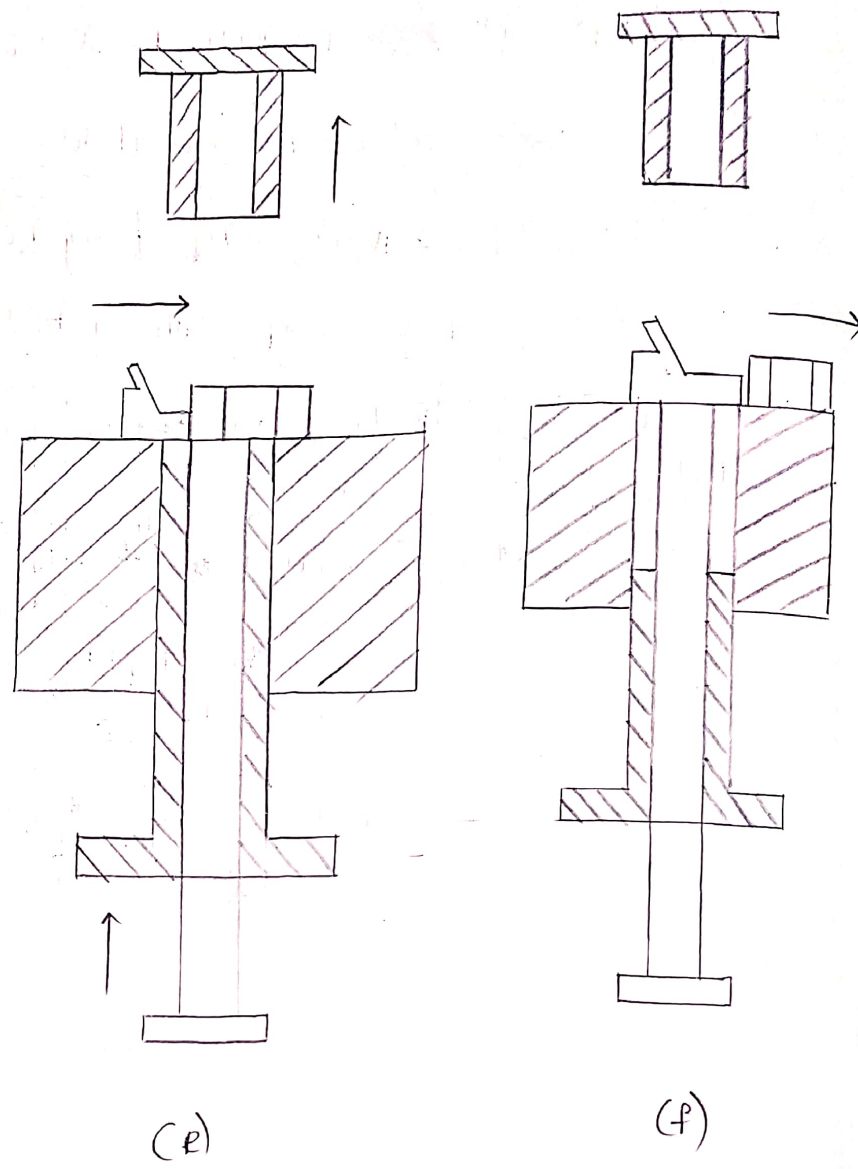

In Compacting, loose powder is Compressed into a shape known as Green Compact. The desired characteristics to be achieved by Compacting are high product density, Uniformity of that density throughout the Compact.

Compacting is generally accomplished by the use of mechanical presses and rigid tools, but hydraulic Presses are also used. Compaction pressures required depending upon the type of material used and

range from 40 - 1650 Mpa.

-At the start of the cycle, the upper punch moves away allowing for the filling of the die cavity as shown in figure (a). The feed shoe completely charges the die with powder as shown in figure (b). Compaction begins after the withdrawal of the feed shoe as shown in figure (c). Compacting process will be completed when the punches complete their intended travel as shown in figure (d). Then the upper punch is retracted and the part is ejected using the lower punch as shown in figure (e). The cycle will be repeated with the removal of the green compact and recharging for the next cycle as shown in figure (f).

It is necessary that in order to achieve quality in the final parts the amount of powder delivered to the die and the movement of punches in the die set remain the same for all the components in the batch. The powder particles move primarily in the direction of applied force. The powder simply compresses until an equivalent opposite force is created. The mechanics of compactions are largely governed by friction between the die and the powder and between the powder particles. The goal during



the Compaction Cycle is to impart uniform density throughout.

AAA \* Sintering:-

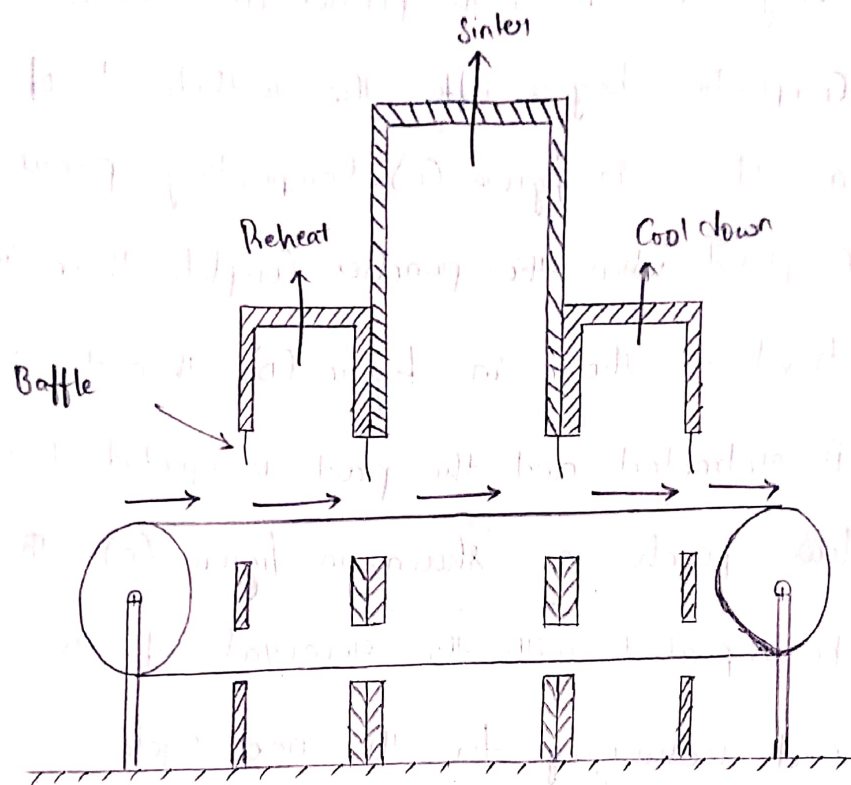

Sintering refers to the heating of the green compact in an oven. The heat is supposed to join the various grains into a single mass, thus developing the necessary strength. The strength obtained in the process depends on the temperature and time, the powder compact is supposed to be in the oven.

The traditional furnace found in the P/M industry (Powder metal industry) is a mesh belt furnace with three operating zones; A preheat zone where the lubricants and binders are burned off; A sintering

Zone where the necessary strength develops and a  
Cooling zone as shown in figure.